

EXP VISION

PRICELIST V2016.5

Our range is constantly expanding, if there are things you don't see, please ask and we will see how we can help you.

*Our focus is on businesses and VAT-registered customers.
For private individuals, we collaborate with reliable partners.*

PARTNER PROGRAM :

"Become one of our selected partners and enjoy benefits not available to others."

*As a partner, you'll receive a standard X% discount on all orders.
Early access to new products, exclusive content, priority support.*

Mutual growth, free trainings & co-marketing.

*Access to our warehouse facilities for product testing
or preparation – available upon request and mutual agreement*

"The Expovision Team"

EXPOVISION

AV staffels

Period of USE

Start price x coefficient

1 Day	x 1
2 Days	x 1,25
3 Days	x 1,5
4 Days	x 1,5
5 Days	x 1,5
6 Days	x 1,5
1 Week	x 1,5
2 Weeks	x 2
3 Weeks	x 2,5
4 Weeks	x 3
5 Weeks	x 3,5
6 Weeks	x 4
7 Weeks	x 4,5
8 Weeks	x 5
9 Weeks	x 5,5
10 Weeks	x 6
11 Weeks	x 6,5
12 Weeks	x 7

Transport and installation days are free of charge with a maximum of 4 days domestic and 6 days abroad.

Conditions apply if we know at which event material is used.

EXPOVISION

EXPVISION

STAGES

*Our range is constantly
expanding, if there are
things you don't see,
please ask and we will
see how we can help you.*

STAGE Trailer 48m²



PRODUCT SPECS :

Podiumwagen 8 x 6 meter x 5,1 hoog
 Podiumwagen gesloten afmetingen : 9,6 x 2,5 x 3,8h
 Gewicht : 2700 kg
 Podium hoogte : 1 - 1.1 meter
 Clearance : 3,9m front and 3,3m back
 Wings max. gewicht : 300kg/wing
 Roof max. load gewicht : 1000 kg
 Vloer : max. 500kg/m²
 1 podium trap

Opbouwtijd : 60 min / 2 pers.
 Opbouwtijd met wings : 75 min / 2 pers

OPTIES :
 - Transport , berekend per locatie
 - Side Wings U vorm. (RM : ST48WING)
 - Side Wings T , met geprinte front banner op maat.
 - Extra Trappen
 - Stage Ramp
 - Backdrop Molton Black

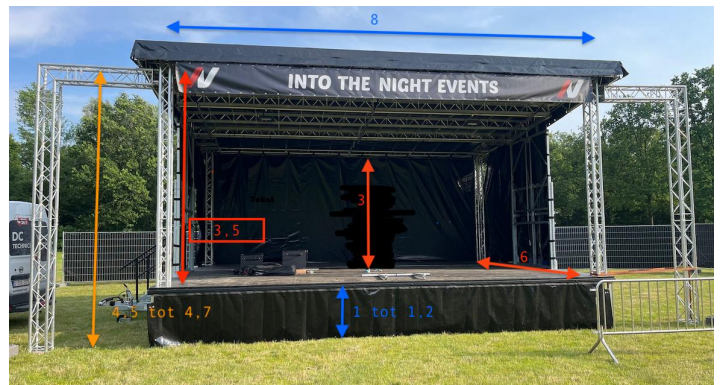

DRY HIRE : NO - Only with Expovision crew

RM PRODUCT CODE : ST48

RENTAL PRICE : Start at 1199,00

CATEGORY : STAGE

While discounts apply to some of our products, this item is already priced at the best rate and is not eligible for further discounts.

STAGE ROOF - Prolyte Arc 8 x 6 incl. PODIUM 48m²



PRODUCT SPECS :

Prolyte Arc roof 8 x 6
Podium 8x6m
1 Podium Trap
4 Beton Gewicht

OPTIES :

- Transport , berekend per locatie
- Side Wings U vorm.Max.belasting 150kg
- Side Wings T , met geprinte front banner op maat.
- Extra Trappen
- Stage Ramp

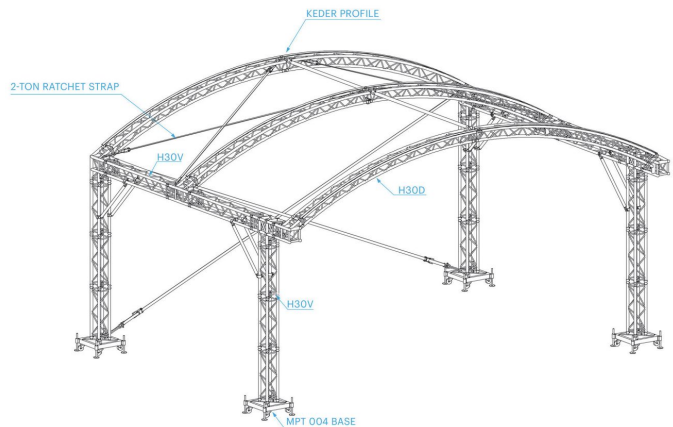
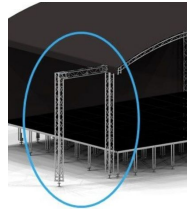

DRY HIRE : NO - Only with Expovision crew

RM PRODUCT CODE : SR48

RENTAL PRICE : Start at 1699,00

CATEGORY : STAGE

While discounts apply to some of our products, this item is already priced at the best rate and is not eligible for further discounts.

STAGE ROOF - Prolyte Arc 6 x 4 incl. PODIUM 24m²



PRODUCT SPECS :

Stage roof 6,6 x 4,7 meter Grijs
Dekzeil + 2 zijkanten + 1 achterkant
Podium : 1 meter hoog 6 x 4 meter
1 podium trap
4 beton gewicht

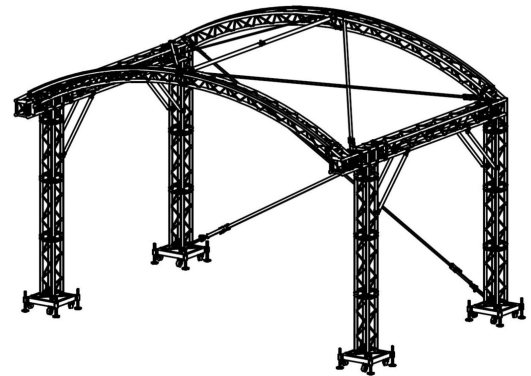

OPTIES :

- Transport , berekend per locatie
- Side Wings U vorm. Max. belasting 150kg (SR24WING)
- Side Wings T , met geprinte front banner op maat.
- Extra Trappen
- Stage Ramp

DRY HIRE : NO - Only with Expovision crew

RM PRODUCT CODE : SR24

RENTAL PRICE : Start at 1250,00

CATEGORY : STAGE

While discounts apply to some of our products, this item is already priced at the best rate and is not eligible for further discounts.

STAGE Trailer MOB 108 108m²



PRODUCT SPECS :

De mob108 is een mobiel podium opgebouwd op een enkel assige oplegger van 22T
Gesloten/rijdende toestand: oplegger van 13m60 lang + trekker, 2m55 breed, vrije hoogte 4m.

Opgebouwd:

Podiumvloer 13m60 op 8m.

Vloerhoogte variabel tussen 1m60 en 2m.

Vloerbelasting max. 350kg/m².

Clearance 5m50.

Dakzeil in polyester, binnen met zwarte rubberlaag.

Luifel vooraan.

Zijzeilen in zwart pvc gecombineerd met PE agroflor. B

randvertragend DIN4102 B1

Dakbelasting max. 4000kg

In het podium zijn riggingpunten voorzien, plan is beschikbaar.

Er zijn mogelijkheden om geluid te stacken of in te hangen.

Er is 1 trap voorzien en een laadram van 1m breed.

Werklicht dmv hpl lampen.

Opbouw en afbraak kan autonoom, voor het werklicht is er een stopcontact 240V nodig.

Dit podium wordt hydraulisch pas gesteld en opent ook hydraulisch.

Opbouw in 3u en afbraak in 2u30 door 2 personen.

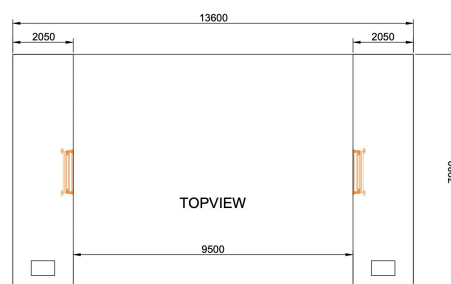

DRY HIRE : NO - Only with Expovision crew

RM PRODUCT CODE : STM0B108

RENTAL PRICE : Start at 5250,00

CATEGORY : STAGE

While discounts apply to some of our products, this item is already priced at the best rate and is not eligible for further discounts.

Small ARC ROOF 4,7 x 3m (DJ roof)



PRODUCT SPECS :

Small arc roof 4,7m W x 3m D x 3,22m H

Roof Grey / Sand Stretch

2 x concrete weight 340kg

6 x Stage Deck 2x1m x 0,4H

Transport costs calculated per location



DRY HIRE : NO - Only with Expovision crew

RM PRODUCT CODE : SMALLARR15

RENTAL PRICE : Start at 650,00

CATEGORY : STAGE

While discounts apply to some of our products, this item is already priced at the best rate and is not eligible for further discounts.

TRUSS BAR / SHOP

NEW



PRODUCT SPECS :

Truss bar / shop

- Tent 5x5 meter / unit
- 1 unit truss = 5,7 wide x 5,3 depth
- Countertop
- Custom printed banners (option)

- Double Tent 10 x 5 meter = 2 units
- 2 units truss = 10,9 wide x 5,3 depth
- Countertop
- Custom printed banners (option)

- Incl. safety weights according to location



DRY HIRE : NO - Only with Expovision crew

RM PRODUCT CODE : TRUSSBAR

RENTAL PRICE : Price on demand

CATEGORY : STAGE

While discounts apply to some of our products, this item is already priced at the best rate and is not eligible for further discounts.

Small TRUSS ROOF 5,7 x 3m (DJ roof)



PRODUCT SPECS :

Small roof 5,7 x 3 meter x 3m H Black / Sand

Roof Black Stretch

+ - 18m²

2 beton gewicht 340

OPTIES :

- Transport , berekend per locatie
- Banners op maat geprint.

DRY HIRE : NO - Only with Expovision crew

RM PRODUCT CODE : SMALLR18

RENTAL PRICE : Start at 499,00

CATEGORY : STAGE

While discounts apply to some of our products, this item is already priced at the best rate and is not eligible for further discounts.

Line Array Layher TOWER 2m x 2 m - 6m High



PRODUCT SPECS :

2,07 x 2,07 x 6,00 High
Rain cover

DRY HIRE : NO - Only with Expovision crew

RM PRODUCT CODE :

RENTAL PRICE : Price on demand

CATEGORY : STAGE

TRUSS BALLAST - 625 kg
Prolyte / Next 30/30

NEW



PRODUCT SPECS :

80 x 80 X 50cm H
625 kg
Prolyte / Next
F-type truss 30/30

DRY HIRE : YES

RM PRODUCT CODE : TRBAL625

RENTAL PRICE : 50,00

CATEGORY : STAGE

STAGE DECK Prolyte / Next

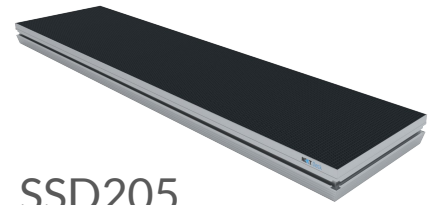
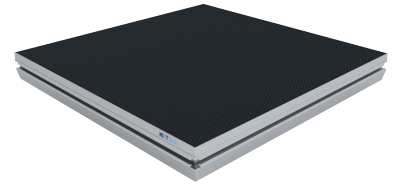
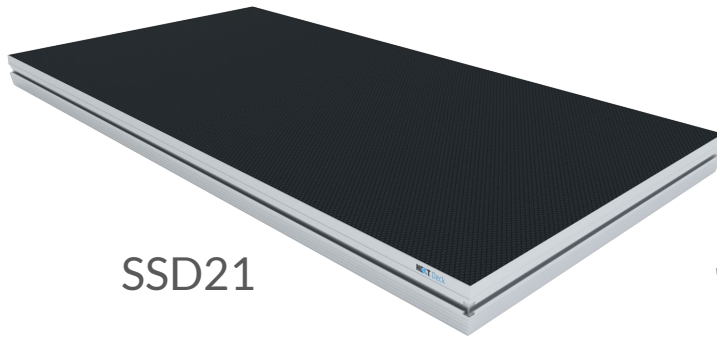

PRODUCT SPECS :

Black Finish

Available in: 2 x 1 m
2 x 0,5 m
1 x 1 m

Calculated with 1/10 of the vertical load transferred into a horizontal load (conform DIN 15921 / EN 13814)

Loading types (for all decks except Acrylic)

Uniformly distributed load	750 kg/m ²
Pointload F1	350 kg
Pointload F2	210 kg
Pointload F3	500 kg

The pointload should be applied to a minimum area of 50 x 50 mm.
Pointload to be placed as indicated on drawing.
1 pointload total allowed.

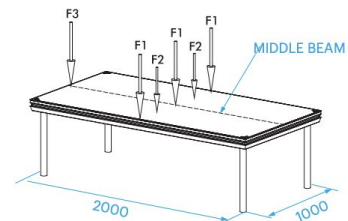

DRY HIRE : YES

RM PRODUCT CODE : SSD21 SSD11 SSD205

RENTAL PRICE : 12,00 (all types)

CATEGORY : STAGE

STAGE LEGS

Prolyte / Next

STAGE Clamp

Deck to Deck Clamp

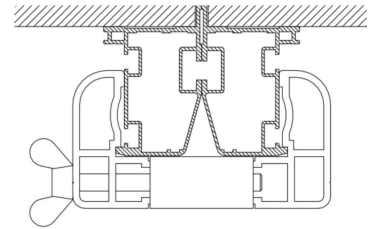
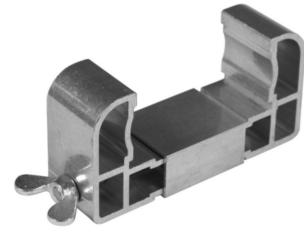

PRODUCT SPECS :

Available :

20 cm
40 cm
60 cm
80 cm
100 cm

ADJUSTABLE form 90 → 140 cm

Deck to Deck clamp
For Prolyte en Next decks

Rm code : SDTDC

DRY HIRE : YES (only in combination with renting decks)

RM PRODUCT CODE : SL20 SL40 SL60 SL80 SL100 SL90140

RENTAL PRICE : 0,50 Pcs / Adjustable 1,25 Pcs / Clamp 0,80

CATEGORY : STAGE

STAGE STAIR

Expovision



PRODUCT SPECS :

Adjustable stair 20 - 40 - 60 - 80 - 100 cm

DRY HIRE : YES

RM PRODUCT CODE : STRAP100

RENTAL PRICE : 30,00

CATEGORY : STAGE

ROLLING RISER LEGS For Next & Prolyte Decks

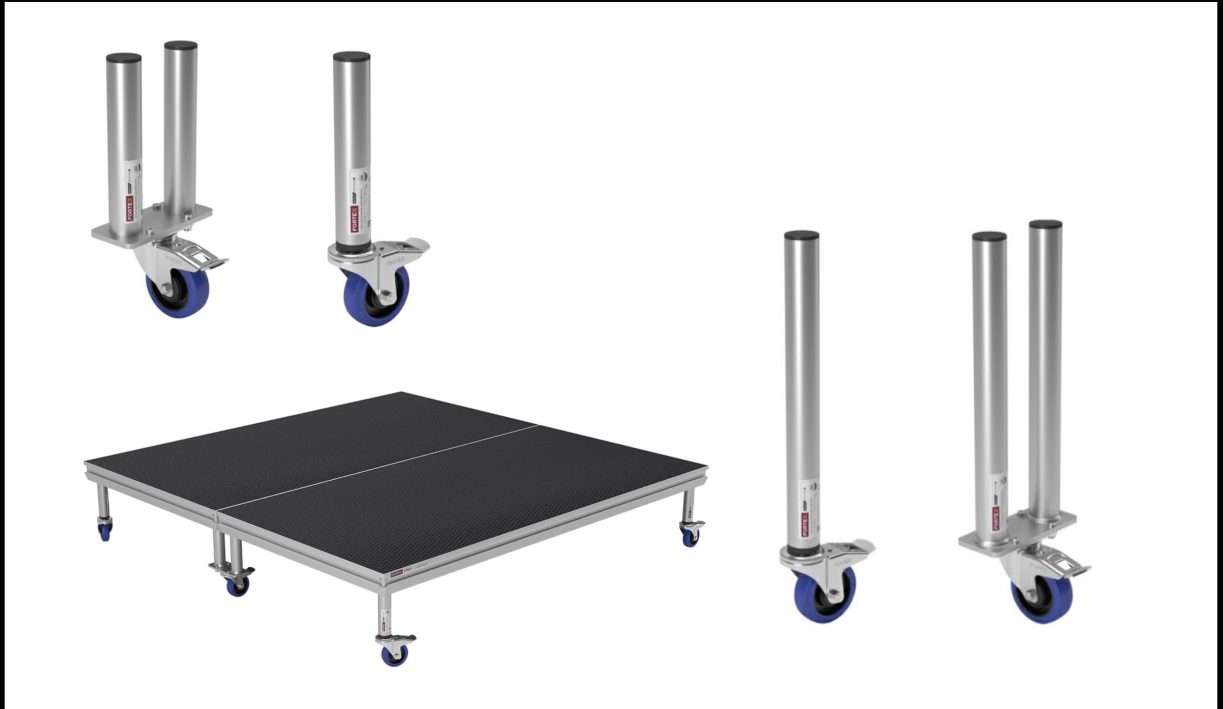

PRODUCT SPECS :

Available :

30 cm	RRL30Solo	-	RRL30Double
40 cm	RRL40Solo	-	RRL40Double
60 cm	RRL60Solo	-	RRL60Double

DRY HIRE : YES (*only in combination with renting decks*)

RM PRODUCT CODE : ..RRL40S RRL40D RRL60S RRL60D

RENTAL PRICE : 2,00 / Pcs

CATEGORY : STAGE

DECK RAILING Prolyte / Next

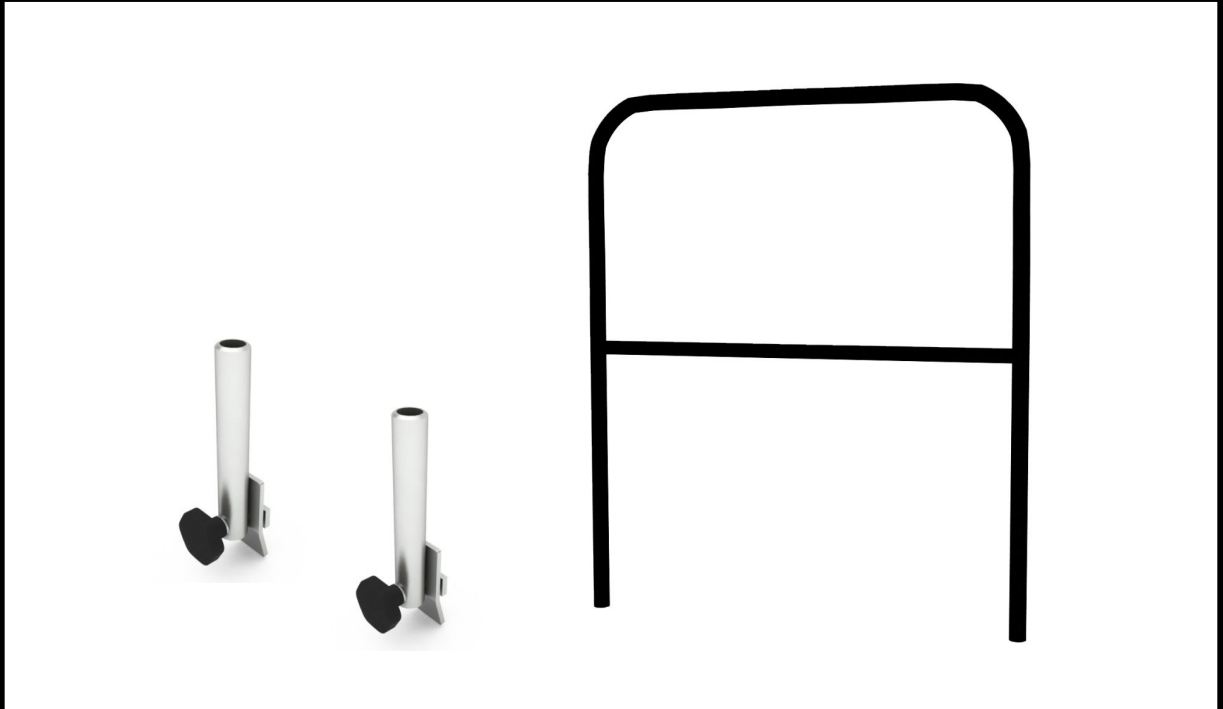

PRODUCT SPECS :

Deck Railing 1 m + 2 adaptor

Deck Railing 2 m + 2 adaptor



DRY HIRE : YES

RM PRODUCT CODE : SDRAIL1

SDRAIL2

RENTAL PRICE :

6,00 / pcs (1m)

10,00 / pcs (2m)

CATEGORY : STAGE

CONCRETE COUNTERWEIGHT

340 kg

145 kg



PRODUCT SPECS :

Counter weight

340 kg

145 kg

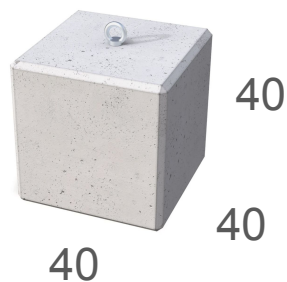
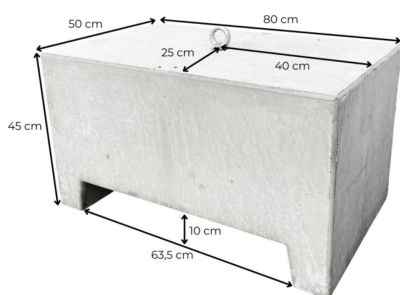

DRY HIRE : YES

RM PRODUCT CODE : SCON340

SCON145

RENTAL PRICE :

20,00

10,00

CATEGORY : STAGE

Crowd control Barrier Stage Barrier



PRODUCT SPECS :

Crowd Control Barrier

Materiaal : Aluminium
Breedt : 100 cm
Hoogte : 109 cm
Diep : 109 cm
Met platform voor beveiliging.



Deur met Kabeldoorvoer

DRY HIRE : YES

RM PRODUCT CODE :

RENTAL PRICE : Price on demand

CATEGORY : STAGE

Regie Tent Small

3 x 3 m



PRODUCT SPECS :

3 x 3 m

DRY HIRE : YES

RM PRODUCT CODE : SREG33

RENTAL PRICE : 50,00

CATEGORY : STAGE

EXPOVISION

EXPVISION

LIGHTS

*Our range is constantly
expanding, if there are
things you don't see,
please ask and we will
see how we can help you.*

LIGHT TOUR SET 1 *(Fast Setup)* 4 Light Tower + 8 front par + 4 Spot



PRODUCT SPECS :

4 x Ballettower with :
4 x CLay Paky Axcor Spot 300 CMY
8 x Briteq Bt-ORBIT Zoom RGBW
8 x Strobe with Aura Effect
8 x Ape Labs Neon Tube dmx
1 x DMX splitter

+ Solo on clamp
8 x TOUR PAR 150W RGBW



OPTION : CHAMSYS MQ with PRE PROG Show : 150,00

OPERATOR : Price on demand

DRY HIRE : YES

RM PRODUCT CODE : LITOUR1

RENTAL PRICE : SETPRICE PROMO 999,00

CATEGORY : LIGHT

While discounts apply to most of our products, this item is already priced at the best rate and is not eligible for further discounts.

CAM-LITE 200 3000->6300K Jb systems



PRODUCT SPECS :

- **CW / WW** - 210W total power.
- Tunable white 3000K → 6300K
- 4 leaf barndoor included.
- Beam angle 110°
- Flicker free dimming with refresh rates between 800Hz and 25kHz.
- Four dimmer curves: linear, square, inverse square, S-curve.
- Easy stand-alone use: 2 rotary knobs for dimming and color temperature adjustment.
- Full DMX control with 2 modes.
- Wireless DMX (optional WTR dongle) or cabled XLR 3pin in/outputs.
- Cooling by natural convection (no noisy fans).
- Rubber feet on the back for use as up-light projector.
- PowerCON compatible in/outputs for easy daisy chaining.



DRY HIRE : YES

RM PRODUCT CODE : LCAM200

RENTAL PRICE : 20,00

CATEGORY : LIGHT

BT-Venuelite4 3000K (24° / 45°) Briteq

NEW



PRODUCT SPECS :

- Fanless
- 3000K warm white
- HI CRI >90
- 4-cell projector
- Thru Con + link
- 160W
- Safety Wire

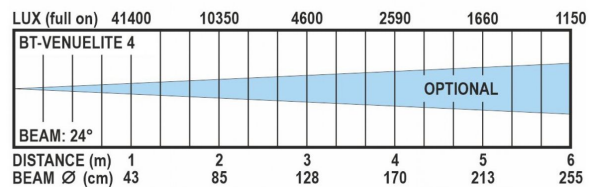
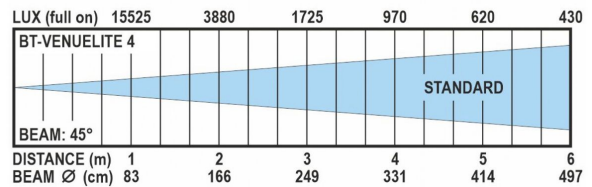

DRY HIRE : YES

RM PRODUCT CODE : LVENUE4

RENTAL PRICE : 25,00

CATEGORY : LIGHT

BT-SUNRAY130R- 3000K Briteq

NEW



PRODUCT SPECS :

Waterproof 130W white COB projector (3000K, CRI>97) with amber drift effect! Super multifunctional: replaces halogen blinders, exhibition projectors, strobes, ...

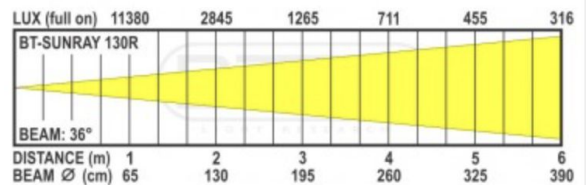
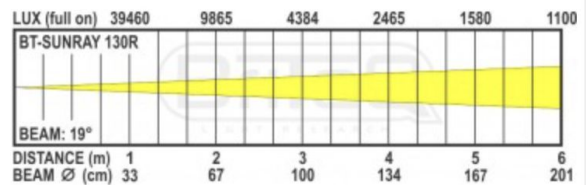

DRY HIRE : YES

RM PRODUCT CODE : LBTSUNRAY

RENTAL PRICE : 22,00

CATEGORY : LIGHT

B-Expoflood 4800K

LUXIBEL

Flood Daylight 4000K

Hoftronic



Waterproof



Waterproof

PRODUCT SPECS :

B Expoflood - 4800K
220W

Toestel is voorzien van een DOORLINK kabel ,
zo kan je 2 toestellen doorlinken in een truss op
max. 1,8m uit elkaar zonder extra kabels.

60°
Zwart armatuur
IP66
+-7,5 kg incl Clamp & safety.

Flood Daylight - 4000k
150 W

120°
Zwart armatuur
IP65
+-7,5 kg incl Clamp & safety.

DRY HIRE : YES

RM PRODUCT CODE : LFL4800 LFL4000

RENTAL PRICE : 12,00

CATEGORY : LIGHT

TOUR PAR 150 - RGBW FOS



IP65



PRODUCT SPECS :

IP65 Weatherproof par, 1 x 150W RGBW LED module, Beam Angle: 80°, OLED touch display, 4 Dimmer Curve, DMX channel: 1/4/6/7/8/11 channels , Waterproof TRUE Con in/out, Double hanger design, Outstanding color mixing effect. noiseless cooling system, barndoor included, 4.2kg. IP65, suitable for outdoor use.
DMX signal input and output with 3pin XLR.
Power In and Output with Waterproof PowerCON.
PMW rated: 900 - 10000 Hz.
Fan modes: Silent / Smart / Max.
Double yoke for multiple installation options.
Power Supply: 100 / 240 Volt AC, 50 / 60 Hz.
Power Consumption: 150 Watt max.
Dimensions: 247 x 234 x 307 mm
Weight: 3,5 Kgs.



DRY HIRE : YES

RM PRODUCT CODE : LTP150RGB

RENTAL PRICE : 20,00

CATEGORY : LIGHT

B-PAR 180 RGBW Luxibel



PRODUCT SPECS :

- RGBW
- DMX
- IP 65
- True Con
- XLR 5 pin

DRY HIRE : YES

RM PRODUCT CODE : LBPAR180

RENTAL PRICE : 15,00

CATEGORY : LIGHT

COB LED PAR56 - WW Briteq



PRODUCT SPECS :

- COB led PAR 56 (optional Barndoors)
- 100W
- Warm white 3200K
- Wide 60° (optional Narrow lens included 25°)
- safety cable
- Fixed dimming instelbaar of dimbaar via DMX
- XLR 3 pin



DRY HIRE : YES

RM PRODUCT CODE : LCOBPAR56

RENTAL PRICE : 19,00

CATEGORY : LIGHT

NEON TUBE - set 6 pcs APELABS



PRODUCT SPECS :

Light tube for illuminating rooms or for use as a light for indoor use
IP protection rating: IP65
Length: 100 cm
Colour temperature: warm white, 2700 K
Homogeneous light pattern without pixel dots
Full flexibility in colour, brightness, effects and programs
Colour rendering index: CRI 90
Dispersion angle: 180°
Battery operation or continuous operation on mains power possible
Battery life: approx. 15 hours
Controllable via remote control, smartphone app, wireless DMX, KNX
PWM (LED refresh rate) adjustable via smartphone app (500 Hz)
Flanless
Charging voltage lamp: 16 - 19 V
Operating voltage lamp: 12 V



DRY HIRE : YES

RM PRODUCT CODE :

RENTAL PRICE : 80,00

CATEGORY : LIGHT

AXCOR SPOT 300 - CMY Claypaky



PRODUCT SPECS :

- 180W White LED Engine
- 8° - 40° Zoom
- One color wheel with 7 colors (including 1 CTO filter)
- CMY color system
- One wheel with 7 rotating gobos
- One wheel with 10 fixed gobos
- Rotating 4-facet prism
- Mechanical Iris
- Frost filter
- Movement: - Tilt: 270° - 16bit - Pan: 540° - 16bit
- Automatic repositioning
- Mechanical Pan/Tilt lock for safe transportation and maintenance
- Beam: Motorized Zoom and Focus
- Dimmer/Shutter: 16-bit Electronic Dimmer with 4 curves
- Shutter and Strobe effect



DRY HIRE : NO

DRY HIRE PROF. USERS only : YES

RM PRODUCT CODE : LAXCOR300

RENTAL PRICE : 60,00

CATEGORY : LIGHT

INNO COLOR BEAM Z19 ADJ



PRODUCT SPECS :

Source

- 19 OSRAM RGBW QUAD-LEDs
- 5436 Lumens (Zoom out, full on)
- 9960 Lux @5m at 10°
- 694 Lux @5m at 60°

Optics

- Motorized Zoom: 10°-60° (field angle)
- 16bit Electronic Dimming 0-100%
- 4 Dim Curves (Square, Linear, Inverted Square, S-Curve)
- 16bit Pan 540°
- 16bit Tilt 270°
- RGBW Color Mixing



DRY HIRE : YES

RM PRODUCT CODE : LINNOWASH

RENTAL PRICE : 35,00

CATEGORY : LIGHT

ORBIT BRITEQ



PRODUCT SPECS :

This successor of the extremely popular BT-W19L10 ZOOM is ready to serve stages, rental jobs and discotheques all over the planet!

The 19pcs 4in1 RGBW 15W leds, combined with redesigned optics increase the output of the original BT-W19L10 ZOOM by 65% !!! (8400 lux @5m /10°)

Extremely bright beam with 3 individually controlled LED-rings and 10° to 60° zoom with perfect color mixing for maximum creativity.

Prepared for wireless DMX: just plug-in an optional WTR-DMX DONGLE ! (Briteq® order code: 4645)

Perfect color consistency and extremely smooth dimming from 0% to maximum output!



DRY HIRE : YES

RM PRODUCT CODE : BTORBIT

RENTAL PRICE : 55,00

CATEGORY : LIGHT

R3 Wash Chauvet



PRODUCT SPECS :

Rogue R3 Wash

Rogue R3 Wash is a feature packed moving wash workhorse ideal for rental and production inventories. It outputs a bright, evenly dispersed light and offers nine zones of LED control to pixel map its 37 (15 W) RGBW quad-LEDs. A quick moving zoom range of 9.3° – 62.6° gives it the spread to cover large areas. Smooth color mixing, simple and complex DMX channel profiles, and powerCON in and out round out the excellent features of this outstanding moving wash.



DRY HIRE : NO

DRY HIRE PROF. USERS only : YES

RM PRODUCT CODE : R3WASH

RENTAL PRICE : 75,00

CATEGORY : LIGHT

SCOTTY BEAM 7r Expovision



PRODUCT SPECS :

17 gobo +white
8 facet prisma
0-3,5°
Wash lens
14 colors + white
7R Lamp
Powercon in / out
3 pin DMX



DRY HIRE : YES

RM PRODUCT CODE : LSCOTTY

RENTAL PRICE : 40,00

CATEGORY : LIGHT

ARAS 150 S



PRODUCT SPECS :

ARAS 150S is a super powered LED moving head with a Luminus 150 W LED.
LED: 1 x 150 W white Luminus LED
power consumption: 300 W @ 230 V
fixed and rotating gobo wheel + open gobo
colour wheel with 7 colours + white
3 and 8 facet dual prism
with auto focus, frost and iris
16 bit movement resolution for pan (540°), tilt (270°) and auto position correction
silent cooling
stand-alone and built-in demo sequences
clear LCD display for easy menu setting

DRY HIRE : YES

RM PRODUCT CODE : LARAS

RENTAL PRICE : 35,00

CATEGORY : LIGHT

Outdoor RGBW par Preprog. kit Luxibel



PRODUCT SPECS :

- KIT 8 PIECES Luxibel B-Par 180
- RGBW
- DMX
- IP 65
- 1 x pre prog DMX recorder
- Cables True Con

DRY HIRE : YES

RM PRODUCT CODE : LSBFCKIT

RENTAL PRICE : 150,00

CATEGORY : LIGHT

LED COB Fourbar RGB JB systems

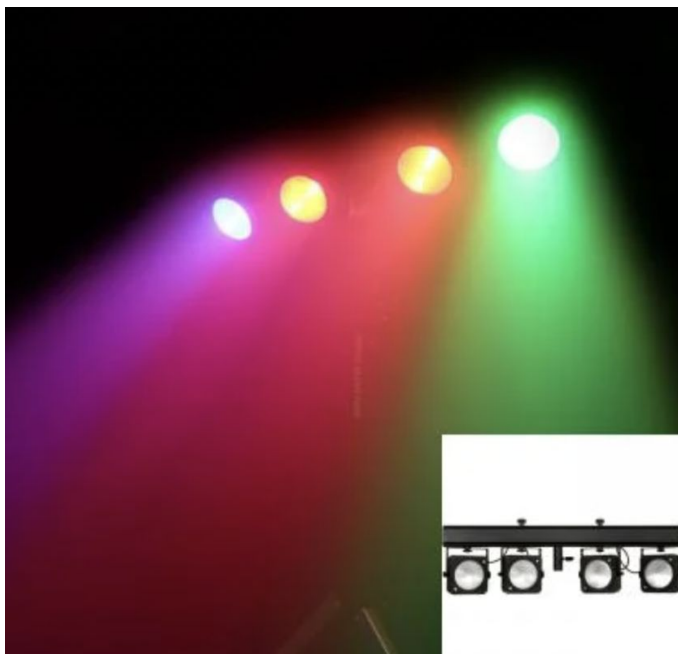

PRODUCT SPECS :

- Build in audio or DMX.
- Op statief of met 2 truss haken

DRY HIRE : YES

RM PRODUCT CODE : COB4BAR

RENTAL PRICE : 35,00

CATEGORY : LIGHT

EZ 15 RGBW mini par Beglec

EZ 15 Warm White Beglec



Waterproof

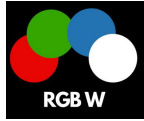

RGB W



Waterproof

WARM WHITE

PRODUCT SPECS :

- RGBW version or WARM WHITE version
- 15 watt outdoor spot
- remote control
- NO dmx
- on demand with ground pin
- on demand with truss clamp



DRY HIRE : YES

RM PRODUCT CODE : LEZ15RGBW or LEZ15WW

RENTAL PRICE : 10,00

CATEGORY : LIGHT

PINSPOT Beamspot1 Triac NW Briteq



PRODUCT SPECS :

- 15 watt LED
- Natural White 4500k
- Manual dimming on back panel

DRY HIRE : YES

RM PRODUCT CODE : PINSPNW

RENTAL PRICE : 10,00

CATEGORY : LIGHT

BUFFET LIGHT with Battery Briteq BT-Accu pole



PRODUCT SPECS :

- Led Accu pole
- 3000K
- Battery-powered (or 240V)
- 4x 5 Watt LED-lighting pole with wireless DMX
- Perfect to light up buffets, presentation counters,

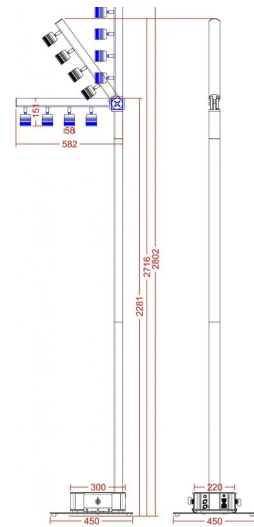

DRY HIRE : YES

RM PRODUCT CODE : LACCUPO

RENTAL PRICE : 60,00

CATEGORY : LIGHT

BEUKY STROBE with aura effect Expovision

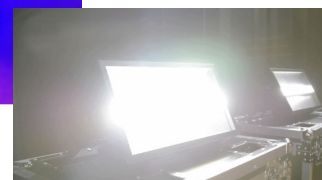
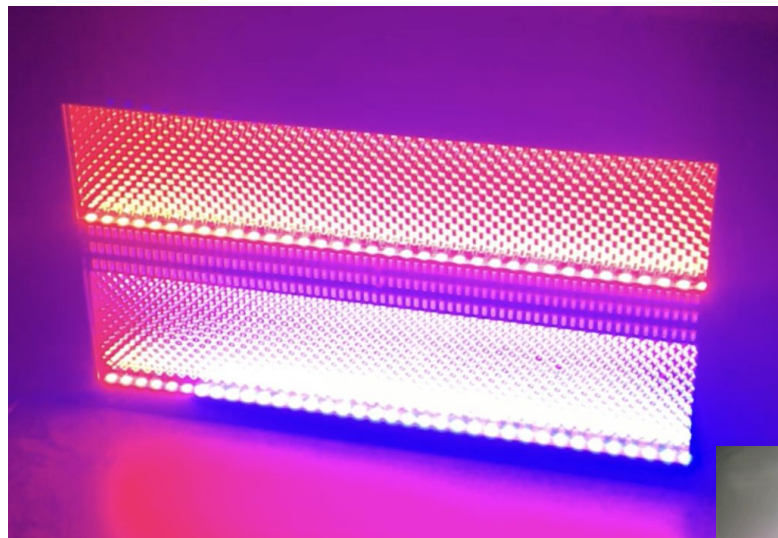

PRODUCT SPECS :

- STROBE** + RGB LED AURA effects
- 170W
- 144 x RGB 3in1 led
- 216 x WHITE Flash Leds
- Auto / DMX or music controlled
- Build in effects
- 7/13/148 dmx channels



DRY HIRE : YES

RM PRODUCT CODE : LBEUKYSTR

RENTAL PRICE : 25,00

CATEGORY : LIGHT

PIXBAR 12 TC

JB systems

NEW

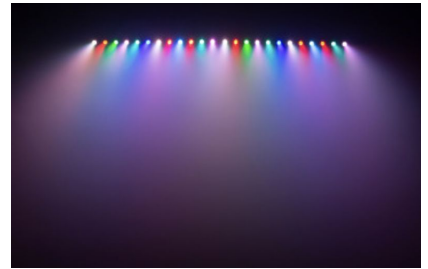

PRODUCT SPECS :

Full color lichtbalk met 12x 3W RGB LED's en individuele pixelcontrole
Powercon



DRY HIRE : YES

RM PRODUCT CODE : LPIXBAR12

RENTAL PRICE : 20,00

CATEGORY : LIGHT

UV - Black Light Strip Kit 10pcs Ibiza



PRODUCT SPECS :

- BLACK LIGHT
- Indoor Use
- 6 x 3 watt / bar
- 10 pieces
- 36 cm



DRY HIRE : YES

RM PRODUCT CODE : LBLKIT

RENTAL PRICE : 75,00

CATEGORY : LIGHT

GOBO PROJECTOR outdoor Divium



PRODUCT SPECS :

The Gobo/effect projector with 30K is an extraordinary performance LED projector thanks to the brand new 30.800 Lumen COB LED, also ideal for bright and brilliant Christmas projections. The Effect version includes quality camera lens and animation disc accessory to ensure high resolution of snowfall and shooting stars effect.

Power consumption 250W
High Efficiency White COB LED
Colour temperature: 6,000 K
Luminous flux: 30.800 lm

Optics
Fixed lens 27° (115mm)
Manual focus
Gobo Rotator that allows you to rotate a gobo or rotate effect wheel

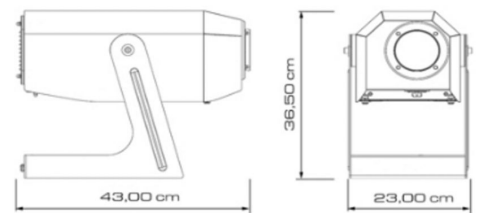

OPTIONS : **Personalised gobo's on demand**

DRY HIRE : YES

RM PRODUCT CODE : LDIVIUM

RENTAL PRICE : 95,00

CATEGORY : LIGHT

BP9-Z Outdoor Washlight Luxibel



PRODUCT SPECS :

36x 15W LED RGBW quick zoom wash light

The B P9Z is a powerful RGBW wash fixture with a quick zoom of 7° - 58°. Every line can be controlled individually for effects and equal coloring of buildings/walls. Thanks to its very versatile bracket, you can suspend this fixture in every way possible: you can even make a line array of lights with them. They come with a honeycomb for unique applications.

- Truecon in & out
- DMX
- Stand-alone

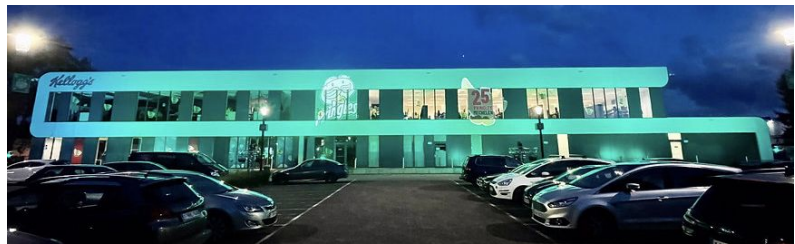

DRY HIRE : YES

RM PRODUCT CODE : LBP9Z

RENTAL PRICE : 65,00

CATEGORY : LIGHT

AURORA BLAST Washlight Luxibel

LUXIBEL



PRODUCT SPECS :

The AURORA BLAST combines **22 high-performance 40-watt RGBW LEDs with 144 5-watt CW LEDs** for rich washes and intense strobes. Its IP65-rated construction thrives in demanding environments, while single dot LED control and a **segmented strobe bar** with 12 controllable zones enable dynamic, thrilling designs. With versatile cooling modes (Silent, High, Auto), a motorized **4° to 45° zoom** and a **motorized 200° tilt**, it adapts seamlessly to any creative vision. The AURORA BLAST's stackable configuration allows for multi-dimensional displays, making it a powerful tool for groundbreaking lighting applications.

DRY HIRE : YES

RM PRODUCT CODE : LAURBL

RENTAL PRICE : 95,00

CATEGORY : LIGHT

Guirlande 50m



PRODUCT SPECS :

- Guirlande 50 m



DRY HIRE : YES

RM PRODUCT CODE : LGUIR50

RENTAL PRICE : 60,00

CATEGORY : LIGHT

LED EFFECTS Jb systems / Chauvet



PRODUCT SPECS :

- All kind of small LED effects
- SOLAR, LED DEVIL , MOON , INVADER
- Small Lasers up to 100mW
- Black Light UV Gun 60w

DRY HIRE : YES

RM PRODUCT CODE :

RENTAL PRICE : 20,00 / 30,00

CATEGORY : LIGHT

LASER BT-1500 RGB Briteq

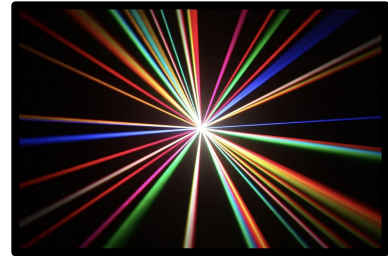
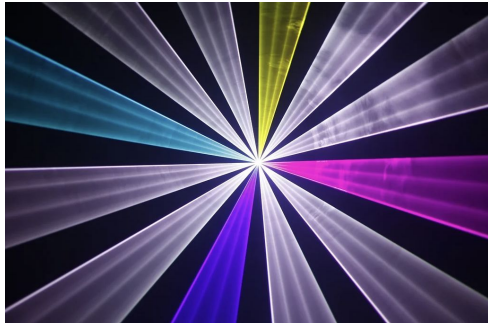

PRODUCT SPECS :

1,5Watt Class-IV RGB color laser equipped with 3 powerful, temperature controlled lasers:

- 500mW Red laser (638nm)
- 200mW Green laser (532nm)
- 800mW Blue laser (450nm)
- music control / master slave / dmx / ILDA / SD card playback

!! Only authorized and well trained operators are allowed to use the laser.

DRY HIRE : YES

RM PRODUCT CODE : LLASERBT15

RENTAL PRICE : 100,00

CATEGORY : LIGHT

LASER BEAMBAR RGB Laserworld

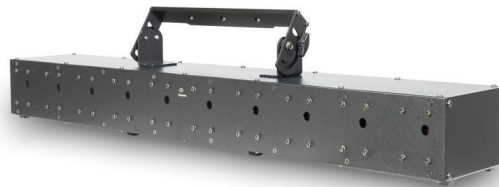
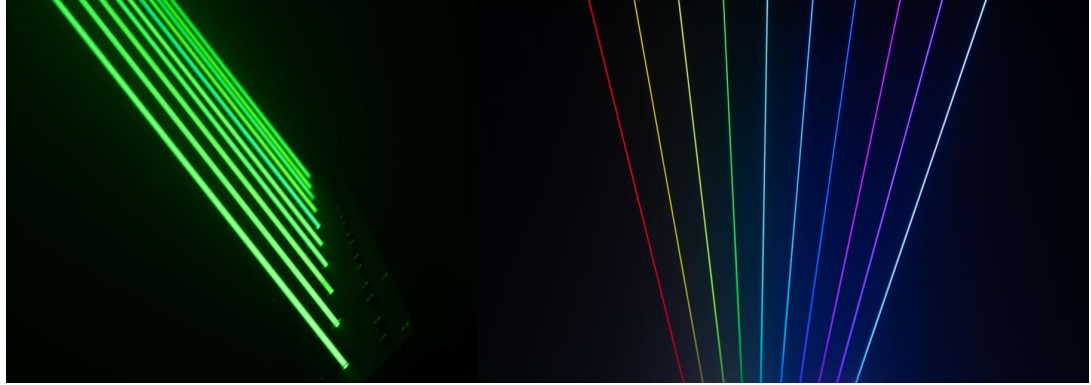

PRODUCT SPECS :

This **special laser effect** creates fans of laser beams and can be **controlled through DMX** or runs in **stand-alone or music mode**.

The Laserworld BeamBar 10RGB is a bar with **10 single beam laser outlets**, each equipped with a **120 mW / 650 nm red, 50 mW / 525 nm green and 80 mW / 450 nm blue laser diode** which means it is possible to create millions of colors and white. **Each laser beam can be individually aligned** through a 4-point alignment system, that can easily be accessed from the front - so no opening of the housing is necessary.

This show laser light provides an **analog modulation**. It means a **better color fading** and a **much broader color hue**. These facts make the Laserworld BeamBar devices ideal for all applications requiring many different color hues and color fadings.

The Laserworld BeamBar 10RGB can be **controlled through DMX channels**, so **each diode can be controlled individually**. Thus it's possible to **create many different chaser, beam or fan effects**.

Due to the standard DMX compatibility, the Laserworld BeamBar 10RGB can **easily be integrated into an existing lighting setup**.

This laser projector provides a **master-slave-mode**. Show lasers of the same series (slave projectors), connected via DMX to a main projector (master projector) project the same patterns like the master projector.

DRY HIRE : YES

RM PRODUCT CODE : LLASERBEAMB

RENTAL PRICE : 100,00

CATEGORY : LIGHT

LASERSHOW



PRODUCT SPECS :

Lasershow a la carte with high power LASERS

Options :

- Audio
- Time code shows
- Smoke , Flames
- Lights & other Special FX

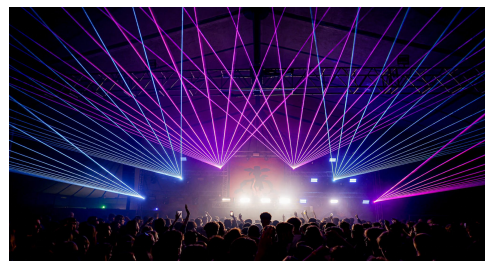

DRY HIRE : NO

RM PRODUCT CODE : LASERSHOW

RENTAL PRICE : Price on demand

CATEGORY : LIGHT

BATTERY UPLIGHTER Expovision



PRODUCT SPECS :

- Stand alone
- DMX wired
- Remote Controller

DRY HIRE : YES

RM PRODUCT CODE : LBATUPL

RENTAL PRICE : 20,00

CATEGORY : LIGHT

RAILSPOT + RAILS WW Expovision



PRODUCT SPECS :

- Railspots 60W
- BLACK or WHITE
- Black & White RAILS available in 1m - 2m - 3m
- 1 Cable / rail
- Warm white



DRY HIRE : YES

RM PRODUCT CODE :

RENTAL PRICE : 15,00

CATEGORY : LIGHT

Deco & Design Lights Expovision



PRODUCT SPECS :

DECORATIVE LED Lights

DRY HIRE : YES

RM PRODUCT CODE :

RENTAL PRICE : Start at 20,00 / piece

CATEGORY : LIGHT

EXPOVISION

EXPVISION

LIGHT CONTROLLERS

*Our range is constantly
expanding, if there are
things you don't see,
please ask and we will
see how we can help you.*

MQ 500 Chamsys

MQ 250 Chamsys



NEW



PRODUCT SPECS :

- DMX Controller
- 4 DMX universe up to 256 universes
- Touch Display(s)

OPTION :

CHAMSYS OPERATOR , PROGRAMMER

Price on demand

DRY HIRE : NO

DRY HIRE PROF. USERS only : YES

RM PRODUCT CODE : LMQ500

LMQ250

RENTAL PRICE :

450,00

325,00

CATEGORY : LIGHT - CONTROLLER

MQ PC wing + Shuttle Touch Chamsys



PRODUCT SPECS :

- MagiqQ Stadium Connect + buddy
- Shuttle Touch Screen PC
- **4 DMX UNIVERSE** direct on XLR
- Outputting 64 universes

DRY HIRE : YES

RM PRODUCT CODE : LMQWING4U

RENTAL PRICE : 150,00

CATEGORY : LIGHT - CONTROLLER

Wireless DMX W-DMX Sender + Receiver



PRODUCT SPECS :

Wireless Solutions W-DMX (sender + receiver)

Wireless DMX sender and receiver
R-512 G5 receiver
F-1G5 Tranceiver

Zorgeloos DMX draadloos overbrengen met deze
degelijke zender en ontvanger.
Aansluiting op 5 of 3 pin DMX

DRY HIRE : YES

RM PRODUCT CODE :

RENTAL PRICE : 90,00

CATEGORY : LIGHT - CONTROLLER

DMX Recorder JB systems



PRODUCT SPECS :

DMX Recorder
1 universe

DRY HIRE : YES

RM PRODUCT CODE :

RENTAL PRICE : 30,00

CATEGORY : LIGHT - CONTROLLER

EXPOVISION

EXPVISION

SPECIAL Fx & SMOKE

*Our range is constantly
expanding, if there are
things you don't see,
please ask and we will
see how we can help you.*

SMOKE JET (CO2 smoke effect) Magic FX



NEW



PRODUCT SPECS :

The SMOKEJET blows smoke upwards, downwards or sideways! It can be placed on stage or mounted on a truss. With the built-in power LEDs, you can even colour the smoke. The SMOKEJET is DMX controllable or can be controlled with the included wireless remote control.

Incl. 2,5 L smoke Jet Fluid

DRY HIRE : YES

RM PRODUCT CODE :

RENTAL PRICE : 50,00

CATEGORY : SPECIAL EFFECTS

SPARKULAR 4x - Special Fx AFX

NEW



PRODUCT SPECS :

SET 4 x SPARKULAR
+ 4 vullingen



DRY HIRE : NO

DRY HIRE PROF. USERS only : YES

RM PRODUCT CODE : SFXSPARK4

RENTAL PRICE : 399,00

CATEGORY : SPECIAL EFFECTS

Amhaze Stadium - HAZER Chauvet



PRODUCT SPECS :

- HAZER fluid
- DMX
- Stand Alone

DRY HIRE : YES

RM PRODUCT CODE :

RENTAL PRICE : 40,00

CATEGORY : SPECIAL EFFECTS

ARENA HAZE IP65

Fos

NEW



PRODUCT SPECS :

IP65 weather resistant professional Arena Haze, Ultimate all-in-one fog and haze machine for professional theatrical effects, 12L fluid tank, adjustable output angle IP65 fan, Integrated in a flight case with castors for touring, heat-up time 7 min, output: 55,000 cuft/min, max Output distance:10 m, 2ch DMX 512

DRY HIRE : YES

RM PRODUCT CODE :

RENTAL PRICE : 95,00 + Fog Fluid

CATEGORY : SPECIAL EFFECTS

LOW FOG CLOUDY-PRO AFX



PRODUCT SPECS :

DMX
3000W
FOG LIQUID + WATER TANK



DRY HIRE : YES

RM PRODUCT CODE : SFXLOWFPRO

RENTAL PRICE : 100,00 + fog liquid

CATEGORY : SPECIAL EFFECTS

FX1200 - SMOKE

Jb systems



PRODUCT SPECS :

- SMOKE MACHINE
- Stand Alone
- Normal FOG fluid
- Incl. 1 L FOG FLUID

DRY HIRE : YES

RM PRODUCT CODE :

RENTAL PRICE : 30,00

CATEGORY : SPECIAL EFFECTS

FAZER Z-350 dmx - SMOKE
Antari

FAZER F700 - SMOKE
JB systems



PRODUCT SPECS :

- FAZER
- Stand Alone
- Normal Fog fluid

DRY HIRE : YES

RM PRODUCT CODE :

RENTAL PRICE : 30,00 25,00

CATEGORY : SPECIAL EFFECTS

Confetti Powershot System Magic Fx



PRODUCT SPECS :

- 2 power shot module
- 1 Controller
- 10 CARTRIDGE 80 cm (CONFETTI or STREAMER)

DRY HIRE : YES

RM PRODUCT CODE :

RENTAL PRICE : 159,00

CATEGORY : SPECIAL EFFECTS

EXPOVISION

EXPVISION

AUDIO - SPEAKERS

*Our range is constantly
expanding, if there are
things you don't see,
please ask and we will
see how we can help you.*

DJ set PRO

Turbosound®



PRODUCT SPECS :

- 2 x Turbosound TQ12 - top 500 Watts continuous, 2000 Watts peak power
- 2 x Turbosound TQ15B - sub 800 Watt continu 3.200 Watt piek vermogen
- 2 x K&M pole stand
- 1 x Lab Gruppen PLM 8K44 SP - 8Kw

DRY HIRE : NO

RM PRODUCT CODE :

RENTAL PRICE : 375,00

CATEGORY : SOUND - SPEAKERS - SELF POWERED

IQ 15

Turbosound®

NEW



PRODUCT SPECS :

Enorm geluid met 2.500W piekvermogen

- Heldere, nauwkeurige geluidswaergave van een 15" woofer en 1" tweeter
- Snel en eenvoudig in te stellen dankzij een gebruiksvriendelijke DSP met LCD-display
- Robuust en lichtgewicht - perfect voor draagbare PA en geluidsversterking
- Powercon + link



DRY HIRE : NO

RM PRODUCT CODE : AIQ15

RENTAL PRICE : 40,00

CATEGORY : SOUND - SPEAKERS - SELF POWERED

FLEX 6

AED AUDIO



PRODUCT SPECS :

The FLEX6 loudspeaker is the only professional multipurpose audio product available worldwide on the market, useable for a variety of applications. Because of its multi-purpose way of deployment, this 1.300W RMS powered speaker can be used in several ways. Put the FLEX6 on a pole, stack it and create a column array, fly it as a line array up to sixteen cabinets, put two horizontally on a pole in a sub-top combination, etc. Why would you buy different types of loudspeakers if you can do all the jobs with one multi-functional speaker? The FLEX6 is the most efficient and versatile product for all your future jobs!

- 15° x 100° (-6dB SPL) - rotatable horn (patent pending)
- Integrated rigging
- Multi-functional rotatable logo LED
- 2x handle with integrated pole mount
- Unique power to size ratio
- MAX spl 139 db
- Amplifier Power 2600W Peak 1300W RMS
- Connectivity : Dante, Analog, Bluetooth, NFC
- 16 Kg
- Powercon True + link

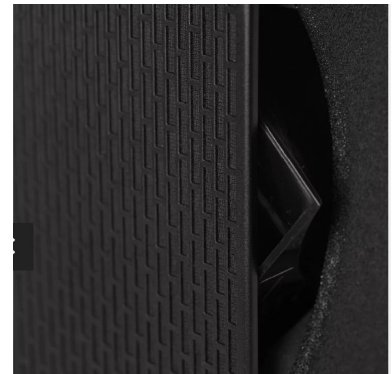

**15° x 110° - rotatable
waveguide (a pend.)**

DRY HIRE : NO

RM PRODUCT CODE : AFLEX6

RENTAL PRICE : 50,00

CATEGORY : SOUND - SPEAKERS - SELF POWERED

SOLID 15

AED AUDIO



PRODUCT SPECS :

The SOLID15 is a compact, single 15 inch, 1.800W RMS low cabinet or subwoofer which can be used in many scenarios and in several configurations. The SOLID15 can be operated standalone, flown and stacked. The front-loaded subwoofer gives you the extra punch that you desire. It is extremely easy to deploy due to the numerous configurations available.

- Compact but powerful
- Integrated rigging
- Multi-functional rotatable logo LED
- Multiple handle with integrated pole mount
- Connectivity : Dante, Analog, Bluetooth, NFC
- MAX SPL 138 db
- Amplifier Power : 3600W Peak - 1800W RMS
- 41 Kg
- Powercon True + link
- Dimensions 620x625x475
- 38 Hz - 120 Hz



Integrated rigging

DRY HIRE : NO

RM PRODUCT CODE : ASOLID15

RENTAL PRICE : 65,00

CATEGORY : SOUND - SPEAKERS - SELF POWERED

SOLID 28

ΔED AUDIO

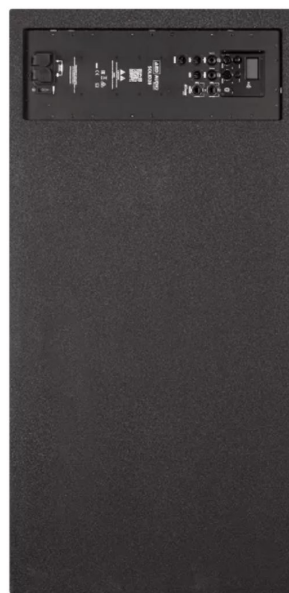
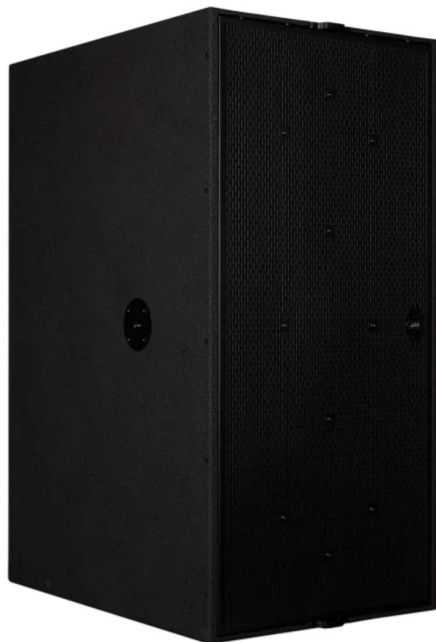

PRODUCT SPECS :

The SOLID15 is a compact, single 15 inch, 1.800W RMS low cabinet or subwoofer which can be used in many scenarios and in several configurations. The SOLID15 can be operated standalone, flown and stacked. The front-loaded subwoofer gives you the extra punch that you desire. It is extremely easy to deploy due to the numerous configurations available.

- Extreme High SPL
- Multi-functional rotatable logo LED
- Multiple handle with integrated pole mount
- Connectivity : Dante, Analog, Bluetooth, NFC
- MAX SPL 140 db
- Amplifier Power : 6000W Peak - 3000W RMS
- 87Kg
- Powercon True + link
- Dimensions 850 x 1210 x 610
- 26 Hz - 60 Hz

DRY HIRE : NO

RM PRODUCT CODE : ASOLID28

RENTAL PRICE : 70,00

CATEGORY : SOUND - SPEAKERS - SELF POWERED

VERTICAL COUPLER

AED AUDIO



With the Vertical coupler you can place 2x AED audio flex 6 vertically on top of each other.

! (MAX 2x AED audio Flex 6)



With the Vertical coupler you can place 2x AED audio Solid 15 vertically on top of each other.

! (MAX 2x AED audio Solid 15)



PRODUCT SPECS :

- Vertical stacking of FLEX6, SOLID15 and SOLID28
- Can be used in all handles on all the AED Audio speakers
- Metal piece, covered with rubber to protect the wood on the cabinets

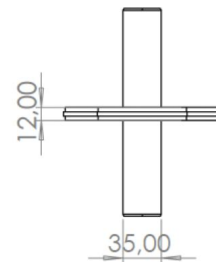
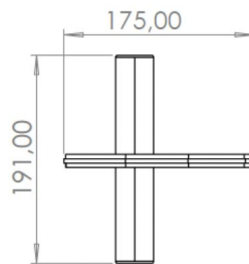

DRY HIRE : YES

RM PRODUCT CODE :

RENTAL PRICE : 3,00

CATEGORY : SOUND - SPEAKERS - SELF POWERED

RIGGING BUMPER



PRODUCT SPECS :

- Fly up to 16x FLEX6 or 8x SOLID15 or any combination in between
- Multiple pickpoints for 1-hoist hangs
- Lightweight (< 13 kg | 29.8 lb)

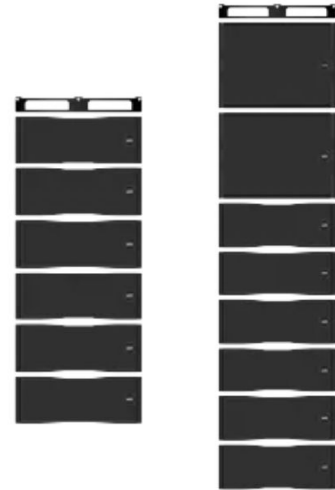

DRY HIRE : NO

DRY HIRE PROF. USERS only : YES

RM PRODUCT CODE :

RENTAL PRICE : 25,00

CATEGORY : SOUND - SPEAKERS - SELF POWERED

YOKE for FLEX 6 / SOLID 15

AED AUDIO



PRODUCT SPECS :

- For max. 2x FLEX6 or 1x SOLID15
- 2x brackets*, 1x pole mount piece included
- Compatible for 30 cm and 40 cm truss (with quicklock)
- Completely foldable
- Fix install directly against a ceiling/wall possible

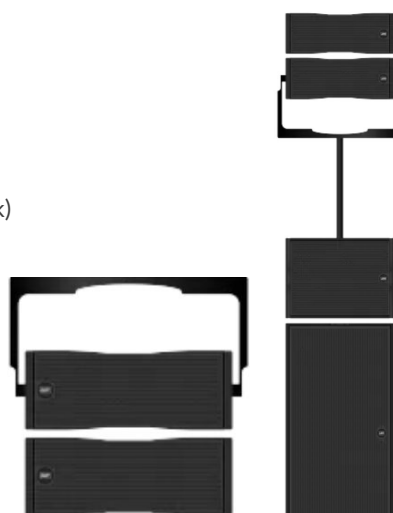

DRY HIRE : YES

RM PRODUCT CODE :

RENTAL PRICE : 8,00

CATEGORY : SOUND - SPEAKERS - SELF POWERED

DJ Audio set Party

ΔED AUDIO



PRODUCT SPECS :

- 2 x Turbosound IQ 15 Active 15"
- 2 x Sub Active 18"
- 2 x K&m pole

DRY HIRE : YES

RM PRODUCT CODE :

RENTAL PRICE : 160,00

CATEGORY : SOUND - SPEAKERS - SELF POWERED

DJ audio set Flex

AED AUDIO

COLUMN set

AED AUDIO

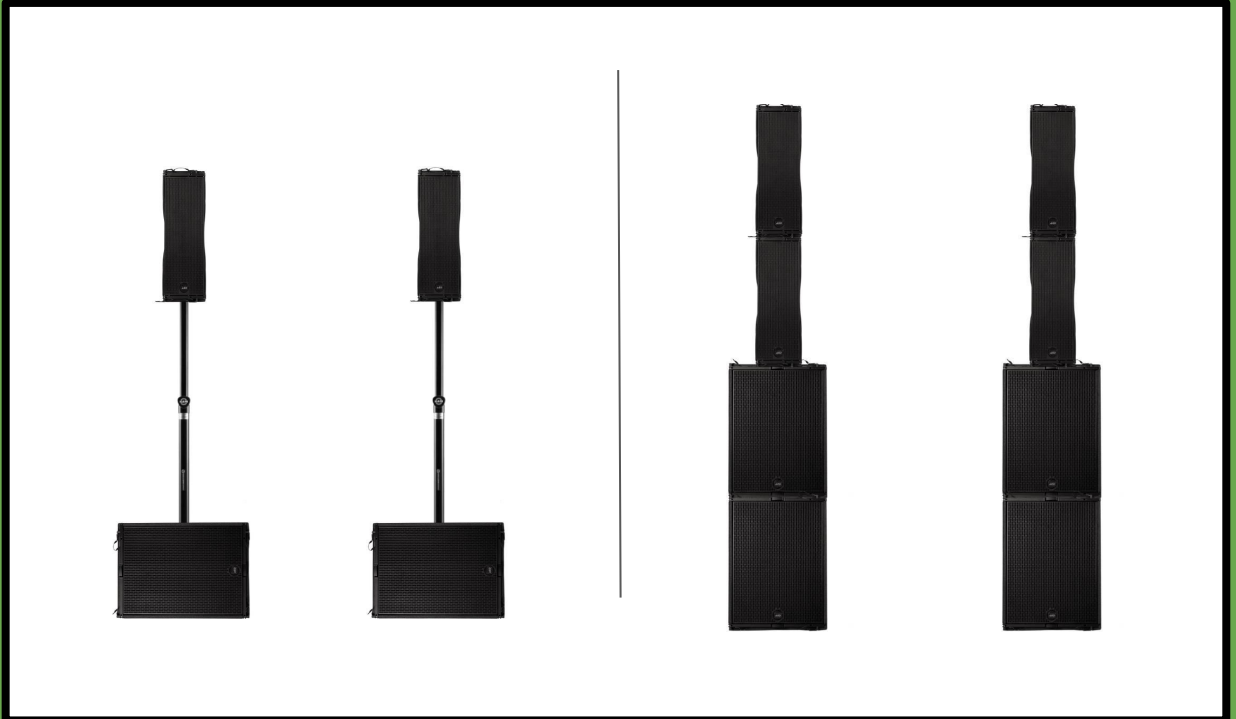

PRODUCT SPECS :

- 2 x flex 6
- 2 x solid 15
- 2 x K&m pole

- 4 x flex 6
- 4 x solid 15 (or 2 x solid 28)

DRY HIRE : YES

RM PRODUCT CODE :

RENTAL PRICE : DJ set flex 230,00 / COLUMN set 460,00

CATEGORY : SOUND - SPEAKERS - SELF POWERED

PA STACK M

ΔED AUDIO

PA STACK L

ΔED AUDIO



PRODUCT SPECS :

- 6 x FLEX 6

- 2 x SOLID 15

- 2 x SOLID 28

- 6 x FLEX 6

- 4 x SOLID 15

- 2 x SOLID 28

DRY HIRE : YES

RM PRODUCT CODE :

RENTAL PRICE : M / 570,00

L / 700,00

CATEGORY : SOUND - SPEAKERS - SELF POWERED

EXPOVISION

Line Array 8-6/2-15/4-28

AED AUDIO

Line Array 12-6/4-28

AED AUDIO

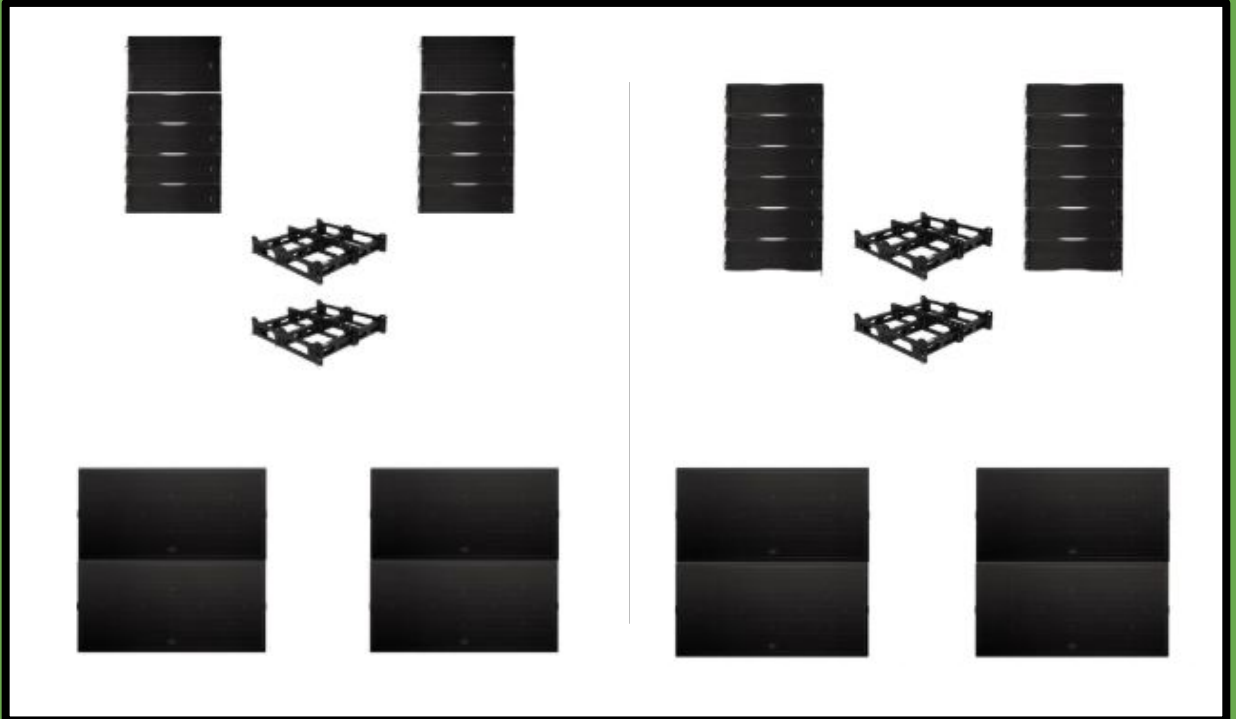

PRODUCT SPECS :

- 2 x 4 flex 6
- 2 x solid 15
- 4 x solid 28
- 2 x rigging Bumper

- 2 x 6 flex 6
- 4 x solid 28
- 2 x rigging Bumper

DRY HIRE : NO

DRY HIRE PROF. USERS only : YES

RM PRODUCT CODE :

RENTAL PRICE :

850,00

900,00

CATEGORY : SOUND - SPEAKERS - SELF POWERED

Line Array 12-6/2-15/4-28

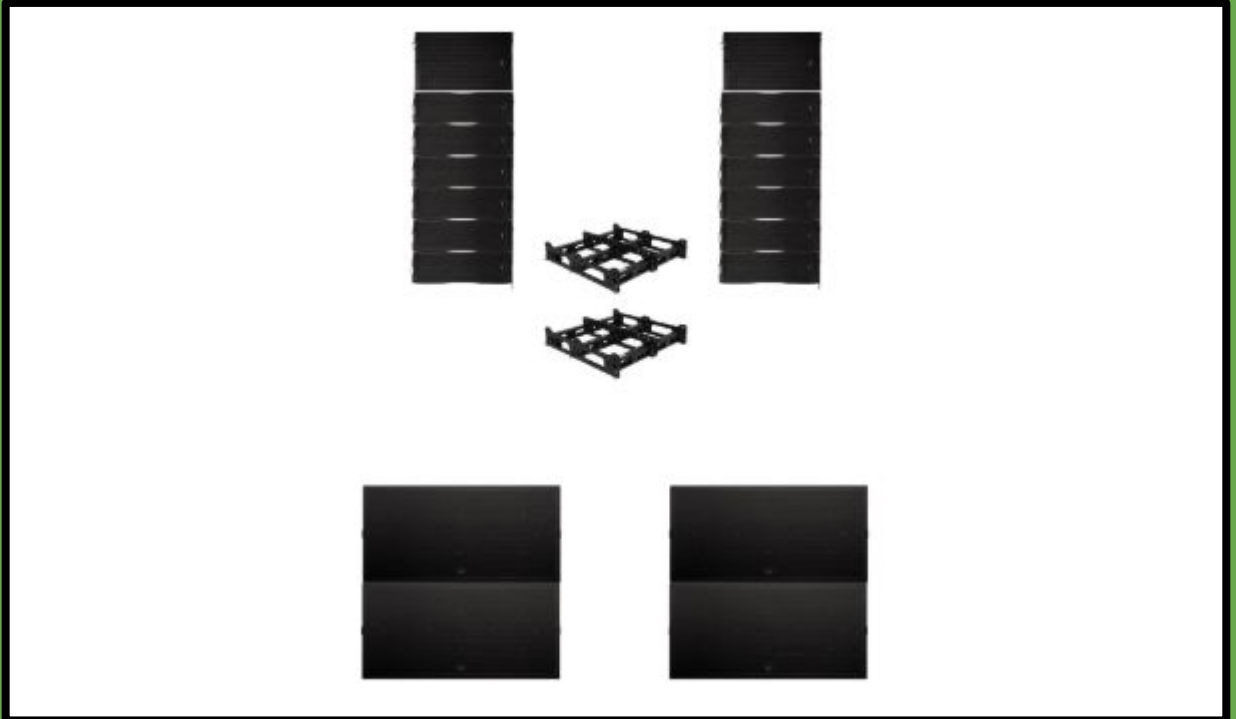

PRODUCT SPECS :

- 2 x 6 flex 6
- 2 x solid 15
- 4 x solid 28
- 2 x rigging Bumper

DRY HIRE : NO

DRY HIRE PROF. USERS only : YES

RM PRODUCT CODE :

RENTAL PRICE : 1150,00

CATEGORY : SOUND - SPEAKERS - SELF POWERED

Line Array setup

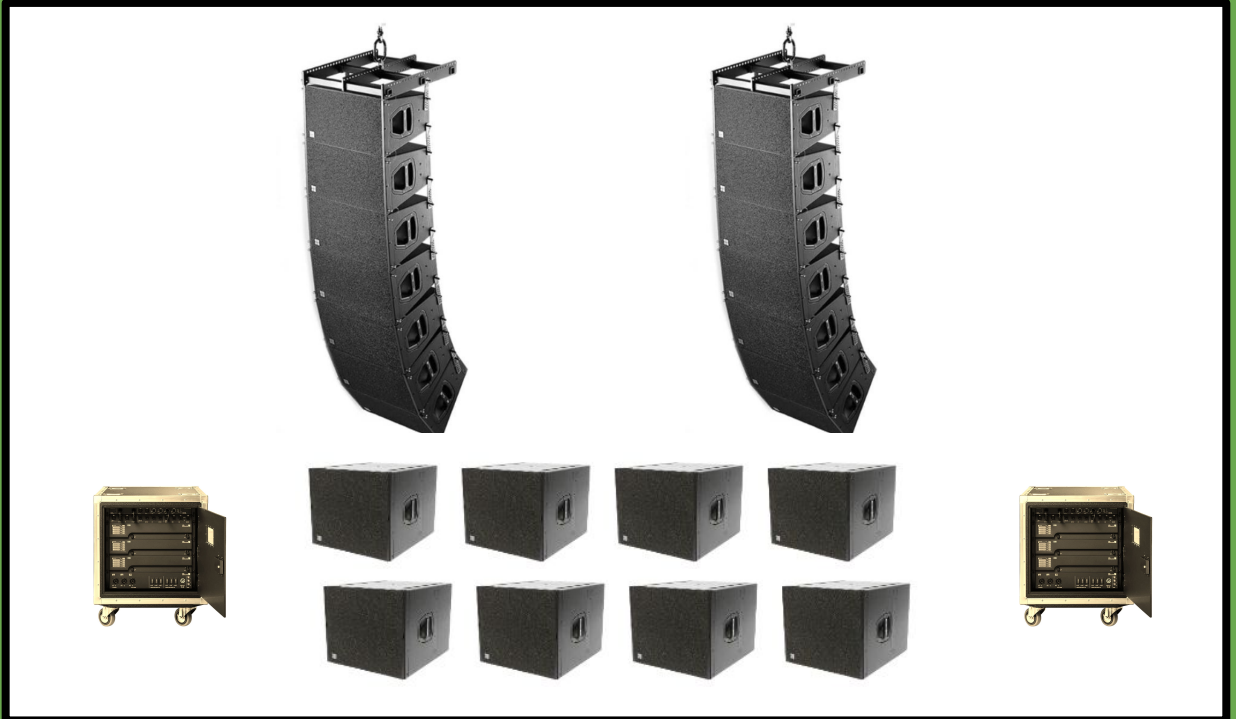

PRODUCT SPECS :

- Line Array Setups on demand

DRY HIRE : NO

Only with Expovision Crew

RM PRODUCT CODE :

RENTAL PRICE : Price on demand

CATEGORY : SOUND - SPEAKERS

SPORT STADIUM set

AED AUDIO

AED AUDIO
THE LEGACY

Sport stadium set

EXPOVISION

72 X Flex 6
24 x Solid 15 Sub
1 x Cable set

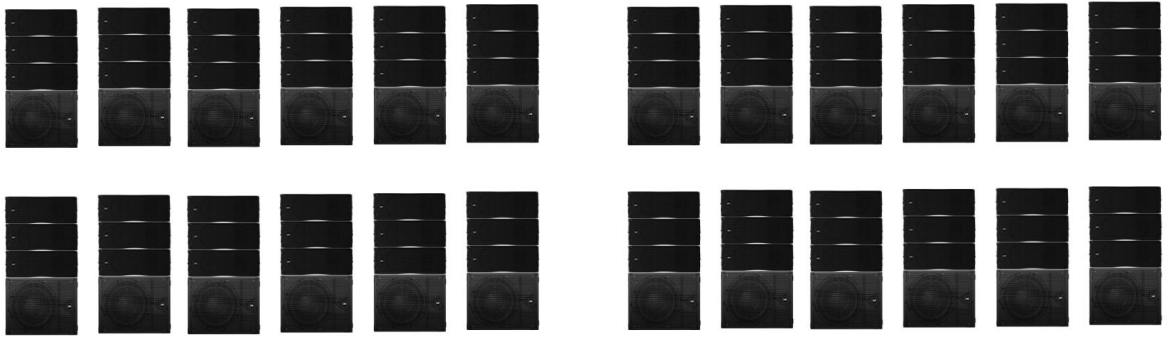

PRODUCT SPECS :

- 72 x 6 flex 6
- 24 x solid 15
- 24 Dolly's
- Power cables
- XLR cables
- CEE cables
- PSU boxes
- 2 technicians
- incl.Transport to venue (50 km from Bornem)

DRY HIRE : NO - only with Expovision crew

RM PRODUCT CODE :

RENTAL PRICE : 7500,00 installed

CATEGORY : SOUND - SPEAKERS - SELF POWERED

X12 - Monitor L-Acoustics

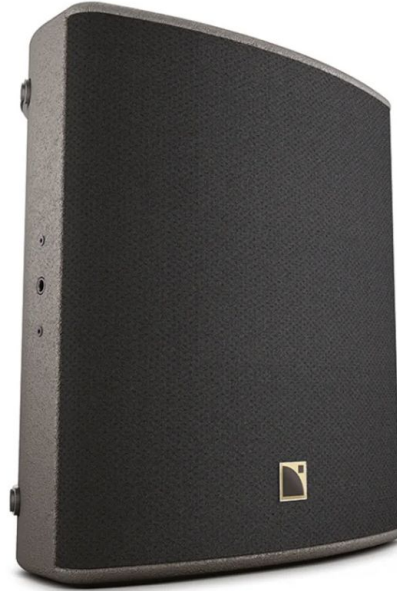

PRODUCT SPECS :

Passive 2-way coaxial enclosure, controlled and amplified by LA4X 59 Hz - 20 kHz
136 dB
Vertical: 90°
Horizontal: 60°
35° without risers
55° with risers
LF: 1 × 12" neodymium, bass-reflex, laminar vents
HF: 1 × 3" neodymium compression driver, ellipsoid waveguide 8Ω
IN: SpeakON®
LINK: SpeakON®
DIN580-compatible M8 threaded insert
4 × M10 threaded inserts
2 × 35 mm pole sockets
20 kg / 44.1 lb
First grade Baltic birch and beech plywood Dark grey brown Pantone® 426C

DRY HIRE : NO

DRY HIRE PROF. USERS only : YES

RM PRODUCT CODE :

RENTAL PRICE : 37,50

CATEGORY : SOUND - SPEAKERS

12" Actieve Speaker met Headset of hand microfoon



PRODUCT SPECS :

Audiophony

12" portable speaker 250Wrms with USB/SD/BT5.0 drive + talkover + effect

Supplied with 1 receiver F5 (RACER-GoModF5) + 2 antennas (RACER-GoAnt)

Keuze om te gebruiken met bijgeleverde

Headset + beltpack of Hand microfoon

(Beide meegeleverd maar slecht 1 tegelijk bruikbaar.)

DRY HIRE : YES

RM PRODUCT CODE :

RENTAL PRICE : 75,00

CATEGORY : SOUND - SPEAKERS

100V outdoor Speaker System DAP



PRODUCT SPECS :

- Public Address System
- 100 Volt Amplifier
- 10 x 100V Horn
- 14 x cable 20/30 meter
- USB port for MP3
- SD card reader for MP3
- Tuner
- Mic input XLR of JACK
- Mini jack input for MP3 player of PC
- Qinch input Line

DRY HIRE : YES

RM PRODUCT CODE :

RENTAL PRICE : 200,00

CATEGORY : SOUND - SPEAKERS

100V outdoor Speaker System Audac

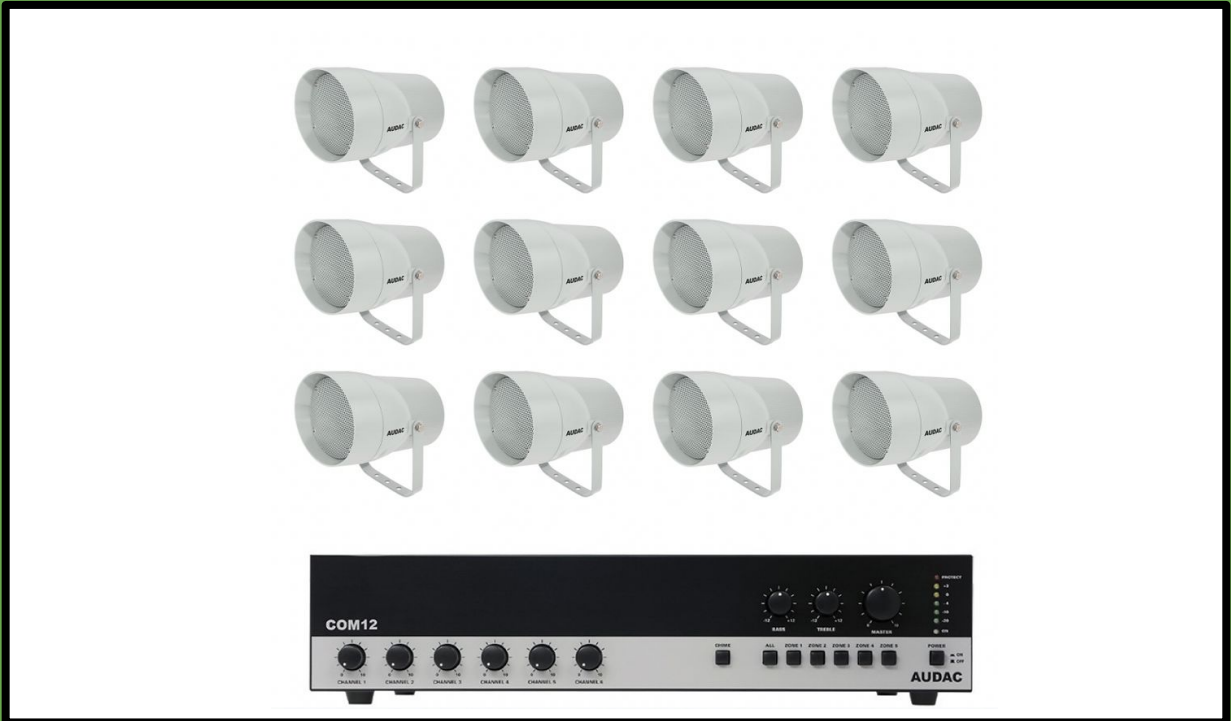

PRODUCT SPECS :

Public Address System
100 Volt Amplifier
12 x 100V Horn Medium Throw

Mic input XLR
Qinch input Line

DRY HIRE : YES

RM PRODUCT CODE :

RENTAL PRICE : 250,00

CATEGORY : SOUND - SPEAKERS

Out/indoor JB Omroep Speaker System

JB systems

NEW



PRODUCT SPECS :

1 x AMP200.4 JB systems 4 x 200W op 4 Ohm

8 x Speaker + Speaker Statief

12 x Luidsprekerkabels speakon 25m

4 x koppelbus Speakon/speakon

Versterker INPUT via 2 x XLR

DRY HIRE : YES

RM PRODUCT CODE : JBomroep

RENTAL PRICE : 250,00

CATEGORY : SOUND - AMPLIFIERS

LA 4X Amplifier L-Acoustics



PRODUCT SPECS :

LA4X: amplified controller with DSP



4 x 1000 W/8 ohms or 4 ohms
4 inputs x 4 outputs architecture
Max 4 enclosures per amplified controller

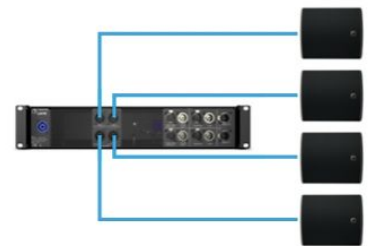

DRY HIRE : NO

DRY HIRE PROF. USERS only : YES

RM PRODUCT CODE :

RENTAL PRICE : 60,00

PLM 8K44 SP Lab Gruppen

LAB.GRUPPEN



NEW



PRODUCT SPECS :

- 8,000 Watt amplifier with 4 flexible output channels and up to 3,800 Watts channel output for touring applications
- Lake digital signal processing for unparalleled loudspeaker management and system control
- Integrated 8x8 channels of dual redundant Dante* digital audio networking with AES67 support
- 4 x 2,000 Watts into 2 Ohms, 4 x 2,000 Watts into 4 Ohms, 4 x 1,500 Watts into 8 Ohms, 4 x 750 Watts into 16 Ohms, 4 x 2,000 Watts into Hi-Z 70 V, 4 x 2,000 Watts into Hi-Z 100 V
- Rational Power Management (RPM) provides total flexibility to allocate available power across all 4 output channels

DRY HIRE : NO

DRY HIRE PROF. USERS only : YES

RM PRODUCT CODE :

RENTAL PRICE : 60,00

CATEGORY : SOUND - AMPLIFIERS

CX702 QSC™



PRODUCT SPECS :

2 x 425 W 8 Ohm
2 x 700 W 4 Ohm
2 x 1200 W 2 Ohm

Input XLR
Output Speakon

DRY HIRE : YES

RM PRODUCT CODE :

RENTAL PRICE : 30,00

CATEGORY : SOUND - AMPLIFIERS

EXPOVISION

EXPVISION

AUDIO
DJ PLAYERS & MIXERS

*Our range is constantly
expanding, if there are
things you don't see,
please ask and we will
see how we can help you.*

XDJ-AZ Alpha Theta



PRODUCT SPECS :

Deze schitterende **4-kanaals standalone DJ controller** heeft de layout en gevoel van de welbekende CDJ-3000 en DJM-A9. Zo voel je je direct thuis achter deze controller na het aansluiten. De full-size jogwheels zijn weer precies gemaakt zoals we van deze controllers gewend zijn. Een snelle reactie en gebruiksvriendelijk als het gaat om scratchen en het bedienen van de pitch bend. Doordat de mixer vrijwel gelijk is aan de DJM-A9 zijn alle knoppen precies te vinden waar je ze wilt hebben. De XDJ-AZ maakt jou dus helemaal klaar om te schitteren op de grote festivals en de lokale clubs!

NEW

DRY HIRE : YES

RM PRODUCT CODE : XDJ-AZ

RENTAL PRICE : 150,00

CATEGORY : SOUND - DJ Players / Mixers / Controllers

PRIME 4 Denon



PRODUCT SPECS :

Stand Alone 4 kanaals DJ controller

- Werkt zelfstandig ZONDER PC
- Werkt met USB sticks - 2 USB poorten
- Werkt met externe HARD DISK
- Werkt met INTERNE SATA hard disk

Importeren van iTunes, Serato DJ Pro, Native Instruments Traktor Pro and Rekordbox® mogelijk.

2 masters op XLR

Multi Touchscreen

DRY HIRE : YES

RM PRODUCT CODE : PRIME4

RENTAL PRICE : 95,00

CATEGORY : SOUND - DJ Players / Mixers / Controllers

CDJ-3000 X Alpha Theta

(previous CDJ3000 also still available)

NEW



PRODUCT SPECS :

DJ Flagship multi media player

DRY HIRE : YES

RM PRODUCT CODE : CDJ3000X

RENTAL PRICE : 110,00

CATEGORY : SOUND - DJ Players / Mixers / Controllers

DJM-A9 Pioneer

NEW



PRODUCT SPECS :

The 4-channel DJM-A9 raises the bar for club standard mixers – boasting huge upgrades compared to its predecessor, the DJM-900NXS2 – with stunningly clear sound quality, enhanced playability and connectivity, and a host of new features to help you take your performances to the next level. The DJM-A9 has also been improved as a musical instrument for more emotional and dynamic performances, while retaining the functions and layout that have become club standards.

DRY HIRE : YES

RM PRODUCT CODE : DJM-A9

RENTAL PRICE : 110,00

CATEGORY : SOUND - DJ Players / Mixers / Controllers

DJM-900 NXS2 Pioneer



PRODUCT SPECS :

Pioneer DJ Mixer

DRY HIRE : YES

RM PRODUCT CODE : 900NSX2

RENTAL PRICE : 75,00

CATEGORY : SOUND - DJ Players / Mixers / Controllers

CDJ-2000 NXS2 Pioneer DJ



PRODUCT SPECS :

Pioneer DJ Player CDJ-2000NXS2

DRY HIRE : YES

RM PRODUCT CODE : CDJ2000NXS2

RENTAL PRICE : 75,00

CATEGORY : SOUND - DJ Players / Mixers / Controllers

EXPOVISION

EXPVISION

AUDIO

P.A. , Mic's , Consoles

*Our range is constantly
expanding, if there are
things you don't see,
please ask and we will
see how we can help you.*

Full PA Service

AUDIO - P.A. - STAGE - LIGHTS - TECHNICIANS



PRODUCT SPECS :

Expovision can be relied upon as a **full-service partner** for **live events**, providing all essential technical solutions—including professional **lighting**, high-quality **sound** systems, mobile **outdoor stages**, and experienced technicians to ensure flawless execution.

DRY HIRE : YES

RM PRODUCT CODE : FULLPASERVICE

RENTAL PRICE : Price on demand

CATEGORY : PA service

Audio Rack

With bluetooth audio receiver and 2 wireless microphone Beta 58
4 Micro inputs / 3 Stereo inputs / 6 Stereo Output Zones



PRODUCT SPECS :

- Alesis Multimix Audiomixer
- Shure SLXD24D with 2 handheld BETA 58
- Drawmer DA6 Audiosplitter - 6 Zones Stereo
- Wireless Bluetooth connection with Mixer
- 4 XLR micro inputs
- 3 Stereo line inputs
- also equipped with a slide for your laptop



DRY HIRE : YES

RM PRODUCT CODE : AURACK1

RENTAL PRICE : 145,00

CATEGORY : AUDIO - Rack

Alesis Multimix 10

With bluetooth audio receiver

NEW



PRODUCT SPECS :

- Multimix Audiomixer
- Wireless Bluetooth connection
- 3 Stereo line inputs
- 4 Mono Line inputs
- 4 Mic input XLR
- Aux send & return



DRY HIRE : YES

RM PRODUCT CODE : AMMIX10

RENTAL PRICE : 30,00

CATEGORY : AUDIO - Rack

SQ6 + DX4816

Allen & Heath



PRODUCT SPECS :

**SQ6 Digital Mixer
+ Stage Rack
+ Cat Cable 50 m**

All Add-Ons (V1.6) features all the DEEP and RackFX add-ons from the V1.6 release including:



- OptTronik
- Bus
- Peak Limiter 76
- 16T
- 16VU
- Mighty
- Opto
- MultiBD3 + MultiBD4
- DynEQ4
- De-Esser
- DiGi-GEQ
- Proportional-Q GEQ
- Hybrid GEQ
- Bucket Brigade
- Echo
- Hypabass

DRY HIRE : YES

RM PRODUCT CODE : SQ6kit

RENTAL PRICE : SQ6kit / 200,00

CATEGORY : AUDIO - Console

All kinds of microphones



PRODUCT SPECS :

*Our range is constantly expanding,
if there are things you don't see,
please ask and we will see how we
can help you*

DRY HIRE : YES

RM PRODUCT CODE :

RENTAL PRICE : Starts at 5,00 ...

CATEGORY : AUDIO - Microphones

SLXD 14/153B

Shure Headset

QLX4D / BETA 58

Shure Handheld

NEW



NEW



PRODUCT SPECS :

Draadloos systeem met SLXD
1 bodypack-zender

MX153B Headset

Draadloos BETA 58

Handheld
Ontvanger

DRY HIRE : YES

RM PRODUCT CODE :

RENTAL PRICE : 45,00

45,00

CATEGORY : AUDIO - Wireless Microphone

ULX-D4 / BETA 58 SHURE

NEW



PRODUCT SPECS :

Wireless Microphone BETA 58

DRY HIRE : YES

RM PRODUCT CODE :

RENTAL PRICE : 50,00

CATEGORY : AUDIO - Wireless Microphone

Shure SVC 18-B/C gooseneck Condenser + base



PRODUCT SPECS :

Gooseneck Microphone

DRY HIRE : YES

RM PRODUCT CODE :

RENTAL PRICE : 20,00

CATEGORY : AUDIO - Microphone

MICROPHONE P.A. KIT

Basic

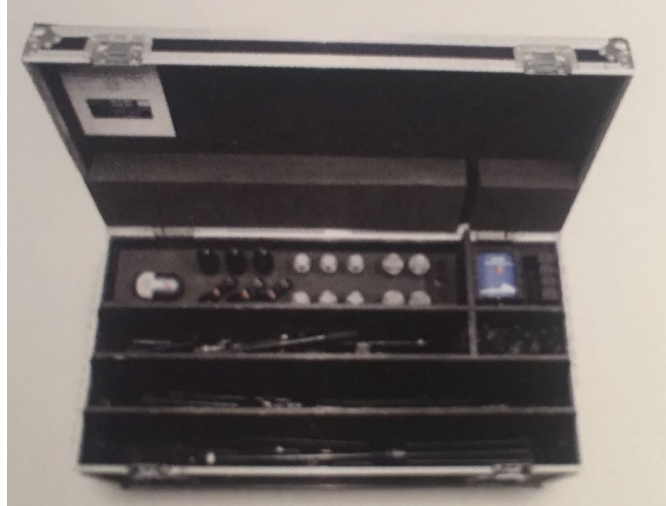

PRODUCT SPECS :

AKG 3x C3000
Sennheiser 3x E604
SHURE 6x BETA 57A / 4 BETA 58A / 1x B52

Di boxes 5 x BSS AR 133 ACTIVE DI

Statieven : 1 x extra small + small boom
6 x small stand + small boom
3 x Medium stand + small boom
4 x Large stand + large boom

DRY HIRE : YES

RM PRODUCT CODE :

RENTAL PRICE : 130,00

CATEGORY : AUDIO - Mic Kit

Drawmer DA6 Audio Distribution Amplifier

NEW



PRODUCT SPECS :

- 2x 6 Stereo Distribution Amplifier
- Monitor output per channel
- 6 XLR outputs
- 2 stereo inputs
- Input and output LED chains
- Each output can be routed - separately to mono or stereo
- Built-in headphone amp

DRY HIRE : YES

RM PRODUCT CODE :

RENTAL PRICE : 50,00

CATEGORY : AUDIO - Audio Signal Distributor

Snakes / Cable reels / Combi



Our range is constantly expanding, if there are things you don't see, please ask and we will see how we can help you



PRODUCT SPECS : *Allerlei kabels & haspels beschikbaar*

- **XLR** 3 pin haspels 50 & 100m
- **DMX** 3 pin / Truecon combi kabels
- **DMX** 3 pin / Powercon combi kabels
- **Speakon** Multi kabels
- **UTP Cat 5 & Cat 6** haspels 50m
- **BNC** haspels 25 & 50m
- **XLR** haspel 50m - 4 paar (2 audio + 2 dmx)
- **XLR** haspel - 8 paar audio
- **XLR** Stage Snakes

DRY HIRE : YES

RM PRODUCT CODE :

RENTAL PRICE : Price on demand

CATEGORY : AUDIO - Cables

MADI DIGITAL Cable Reel 75 ohm HD-SDI 3x BNC



PRODUCT SPECS :

- 75 meter
- 75 Ohm
- 3 x BNC HD-SDI

DRY HIRE : YES

RM PRODUCT CODE :

RENTAL PRICE : 40,00

CATEGORY : AUDIO - Cables

Decibel Meter SPL - D2 + Limiter Dateq dB METING



PRODUCT SPECS :

Dates SPL-D2

Option:
Limiter Unit on XLR

DRY HIRE : YES

RM PRODUCT CODE :

RENTAL PRICE : 35,00 Meter + 50,00 Limiter

CATEGORY : AUDIO - Decibel Meter

Decibel Meter SPL - D3 + Limiter Dateq dB RECORDER



PRODUCT SPECS :

Dates SPL-D3

Option:
Limiter Unit on XLR

DRY HIRE : YES

RM PRODUCT CODE :

RENTAL PRICE : 75,00 Meter + 50,00 Limiter

Protalk Walkie Talkie Kenwood



PRODUCT SPECS :

Walkie talkie
(in ear Headset = optie)

DRY HIRE : YES

RM PRODUCT CODE :

RENTAL PRICE : 15,00 (Headset 2,50)

CATEGORY : AUDIO - Communication

EXPOVISION

EXPVISION

POWER DISTRI
& CABLES

*Our range is constantly
expanding, if there are
things you don't see,
please ask and we will
see how we can help you.*

CEE KABEL 63 A - 32A - 16A 5 pin - 3 x 400V + N



PRODUCT SPECS :

CEE 63 A
5 pin
3 x 400V + N

Lengths :

3 m
5 m
10 m
25 m

CEE 32 A
5 pin
3 x 400V + N

Lengths :

3 m
5 m
10 m
25 m

CEE 16 A
5 pin
3 x 400V + N

Lengths :

3 m
5 m
10 m
25 m

DRY HIRE : YES

RM PRODUCT CODE :

RENTAL PRICE : 0,50/ m 0,35/m 0,25/m

CATEGORY : POWER DISTRI & CABLES

CEE ADAPTOR PLUGS

5 pin - 3 x 400V + N



PRODUCT SPECS :

All kind of adaptors and splitters - on request

DRY HIRE : YES

RM PRODUCT CODE :

RENTAL PRICE : 3,00

CATEGORY : POWER DISTRI & CABLES

CABLE PROTECTION KIT

15 x 2 channel Yellow Jacket



PRODUCT SPECS :

15 x Cable protection 2 channel

DRY HIRE : YES

RM PRODUCT CODE :

RENTAL PRICE : 75,00 / set

CATEGORY : POWER DISTRI & CABLES

SCHUKO KIT (model : 120/40) 240V POWER CORD KIT



PRODUCT SPECS :

- 5X 20m schuko BALS Red Cap 2,5mm²
- 10x 10m schuko BALS Black Cap 2,5mm²
- 5x 5m schuko BALS Green Cap 2,5mm²
- 10x 1,5m powerstrip4 Black perel 1,5 mm²
- 10x 5m powerstrip4 Black perel 1,5 mm²

TOTAL : 40 pieces

DRY HIRE : YES

RM PRODUCT CODE : PSCHUKIT12040

RENTAL PRICE : 60,00

CATEGORY : POWER DISTRI & CABLES

SCHUKO KIT (model : 120/60) 240V POWER CORD KIT - AED



PRODUCT SPECS :

- 10X 3m schuko 2,5mm²
- 10x 5m schuko 2,5mm²
- 10x 10m schuko 2,5mm²
- 10x 20m schuko 2,5mm²
- 10x 1,5m powerstrip4 Black perel 1,5mm²

TOTAL : 50 pieces

DRY HIRE : YES

RM PRODUCT CODE : PSCHUKIT12060

RENTAL PRICE : 110,00

CATEGORY : POWER DISTRI & CABLES

PowerCON TRUE Kit

(model : 60/60)

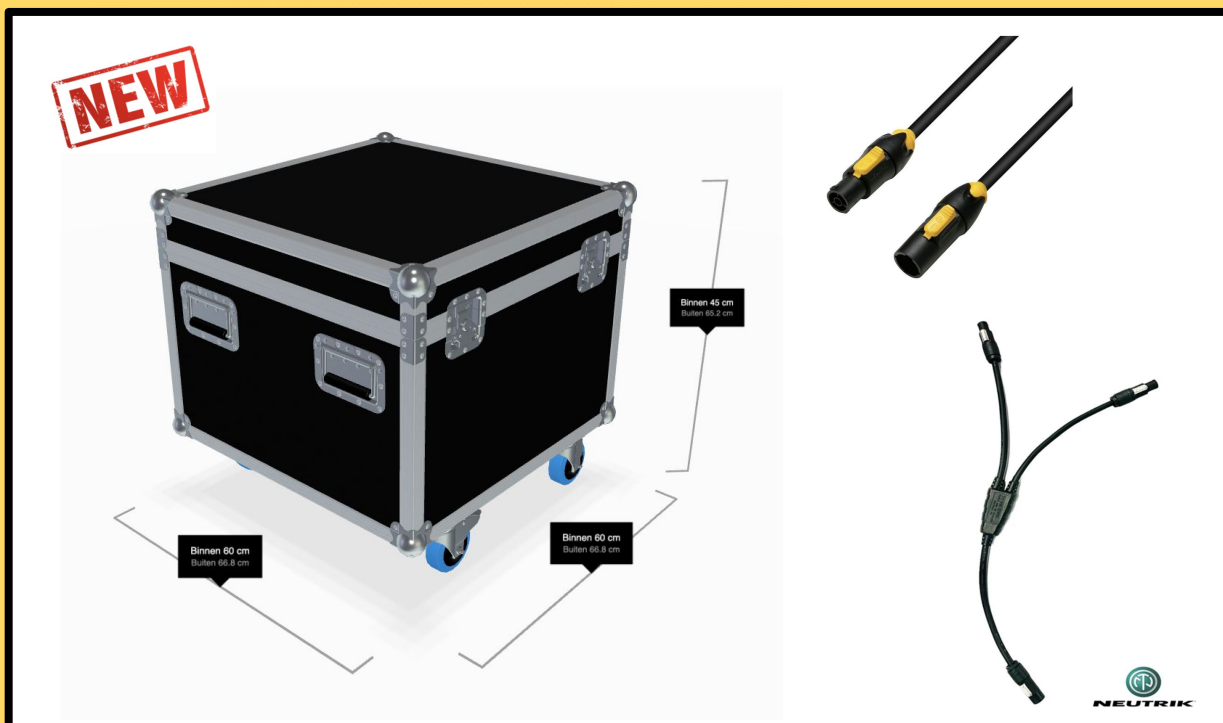

PRODUCT SPECS :

- 10 x Y-split
- 10 x 5m
- 10 x 10m
- 10 x 20m

TOTAL : 40 pieces

DRY HIRE : YES

RM PRODUCT CODE :

RENTAL PRICE : 60,00

CATEGORY : POWER DISTRI & CABLES

XLR 3 pin KIT (model : 60/60) Neutrik

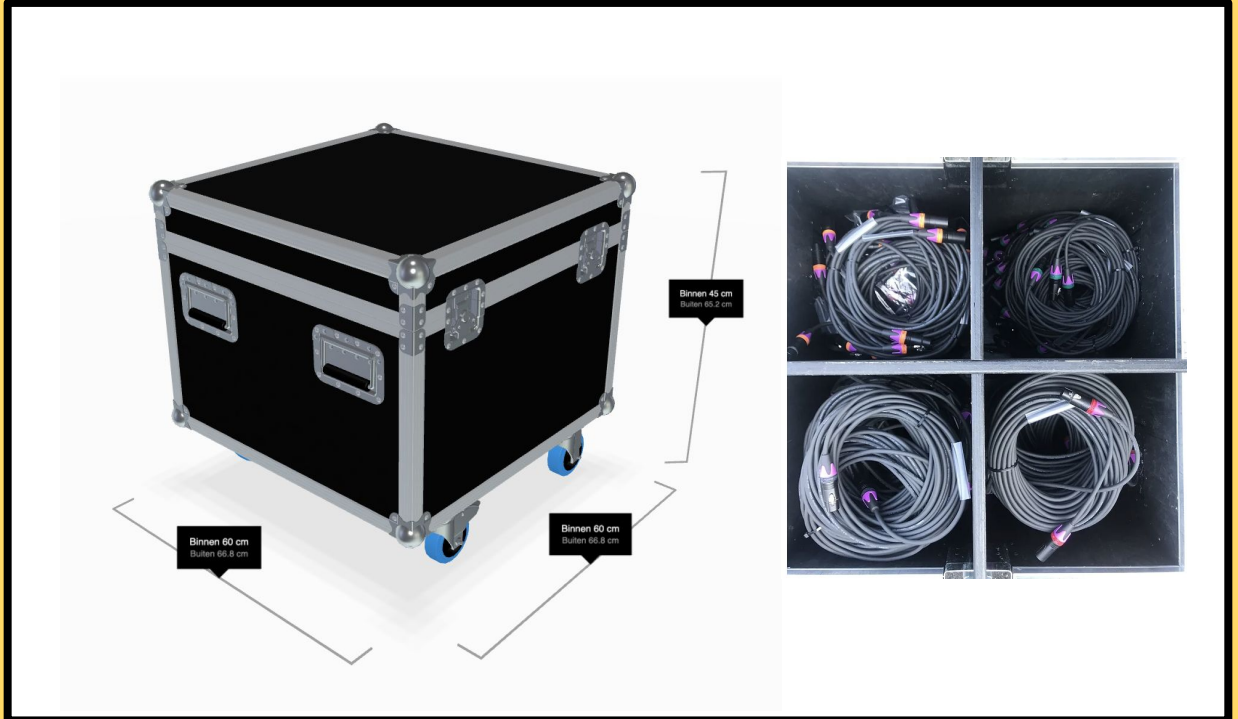

PRODUCT SPECS :

- 10 x 1 m (bruin label)
- 20 x 2 m (rood label)
- 20 x 3 m (oranje label)
- 20 x 5 m (groen label)
- 20 x 10 m (zwart label)
- 10 x 20m (rood label) of 10 x 25m (groen label)



TOTAL : 100 pieces

DRY HIRE : YES

RM PRODUCT CODE :

RENTAL PRICE : 95,00

CATEGORY : POWER DISTRI & CABLES

XLR 5 pin KIT (model : 60/60) Neutrik

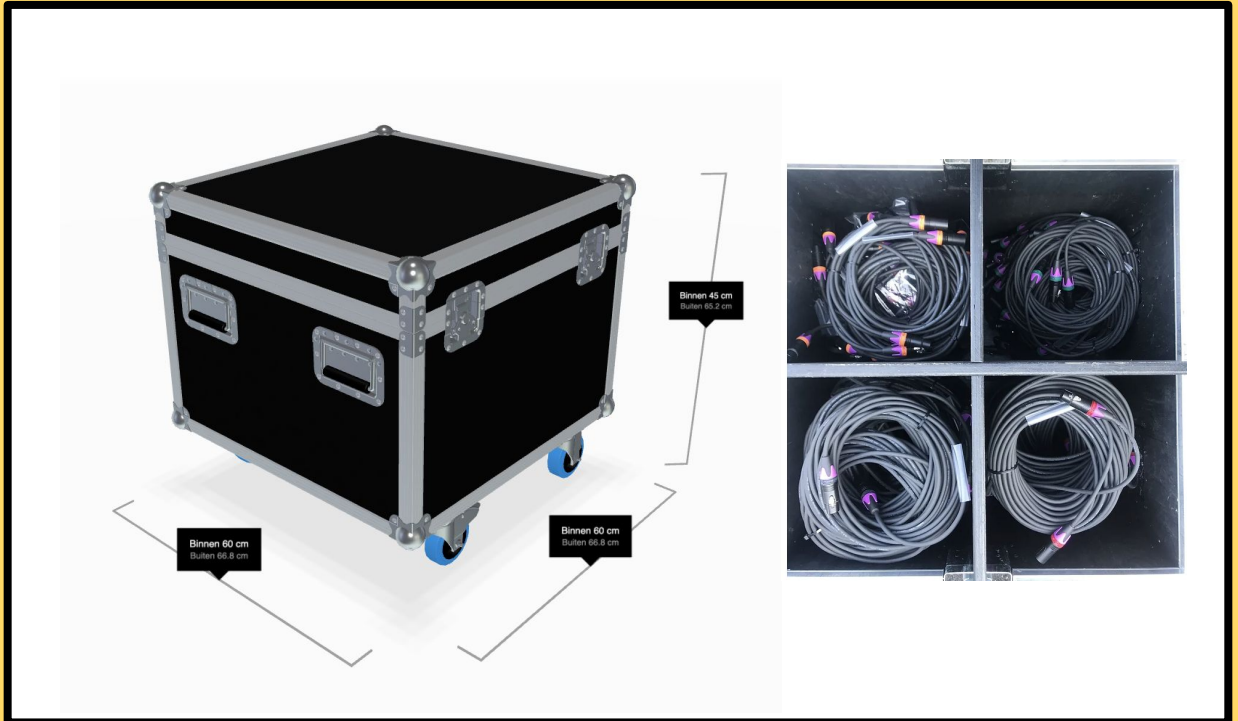

PRODUCT SPECS :

- 20 x 3 m
- 20 x 5 m
- 20 x 10 m
- 10 x 20 m



TOTAL : 70 pieces

DRY HIRE : YES

RM PRODUCT CODE :

RENTAL PRICE : 150,00

PSU 125 A *Power shop* POWER DISTRIBUTION BOX



PRODUCT SPECS :

CEE 125A - INPUT + Link Output

2 x 63 CEE out

4 X 32 CEE out

12 x 240V mono out

Diffs 30ma

DRY HIRE : YES

RM PRODUCT CODE : PSU125

RENTAL PRICE : 125,00

CATEGORY : POWER DISTRI & CABLES

PSU 63 A *Power shop* POWER DISTRIBUTION BOX



PRODUCT SPECS :

CEE 63A - INPUT
2 x 32 CEE out (2 x diff 30mA)
6 x 240V mono out (6 x diff 30mA)

DRY HIRE : YES

RM PRODUCT CODE : PSU63PSH

RENTAL PRICE : 50,00

CATEGORY : POWER DISTRI & CABLES

PSU 63 A - *Qube* POWER DISTRIBUTION BOX

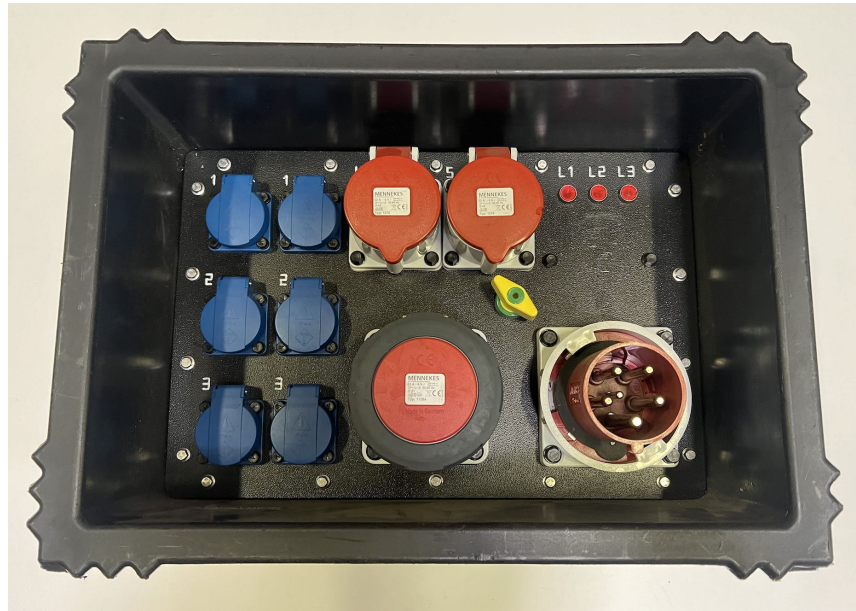

PRODUCT SPECS :

Powerbox 63A - CEE 32A - 5 pin in.
6 x Mono out
2 x CEE 32A out
1 x CEE 63A link
Diff 30mA

DRY HIRE : YES

RM PRODUCT CODE : PSU63QU

RENTAL PRICE : 50,00

CATEGORY : POWER DISTRI & CABLES

PSU 32 A with Harting 16P POWER DISTRIBUTION BOX



PRODUCT SPECS :

Powerbox 32A - CEE 32A - 5 pin in.

8 x Mono out

1 x harting 16P out

Diff 30mA

Options :

- Break out box - 8 channel mono / 16p in / 16p out link 5,00

- Harting Kabel 16P 5/10/15/20m 5,00 / 10,00 / 15,00 / 20,00

DRY HIRE : YES

RM PRODUCT CODE : PSU32PSH

RENTAL PRICE : 45,00

CATEGORY : POWER DISTRI & CABLES

PSU 32 A - Easybox / Wallbox POWER DISTRIBUTION BOX



PRODUCT SPECS :

Easybox 32A
CEE 32A - 5 pin in.
4 x Mono out
2 x CEE 16 A out
1 x CEE 32A link
Diff 30mA

Wallbox 32A
CEE 32A - 5 pin in.
6 x Mono out
Diff 30mA
On wooden plate for
easy mounting

DRY HIRE : YES

RM PRODUCT CODE : PSU32EB

PSU32WB

RENTAL PRICE :

30,00

30,00

POWER GENERATOR Atlas Copco



PRODUCT SPECS :

30 KVa up to 200 KVa

Price on demand

DRY HIRE : YES

RM PRODUCT CODE :

RENTAL PRICE : Price on demand

EXPOVISION

EXPVISION

**Video & It
Robotics
3D productions**

*Our range is constantly
expanding, if there are
things you don't see,
please ask and we will
see how we can help you.*

LED Trailer P3.9 - 6 m² LED Trailer P3.9 - 7 m²



PRODUCT SPECS :

B-rijbewijs
P3.9 Led wall
Outdoor
HDMI input
6m² : 3x2 meter
7m² : 3,5x 2 meter

DRY HIRE : NO - Only with Expovision Crew

RM PRODUCT CODE : LEDTR6

LEDTR7

RENTAL PRICE : *Vanaf* 500,00 / 6m²

595,00 / 7m²

Matrix LED 496 x 496 P1.5 for Matrix frames systems

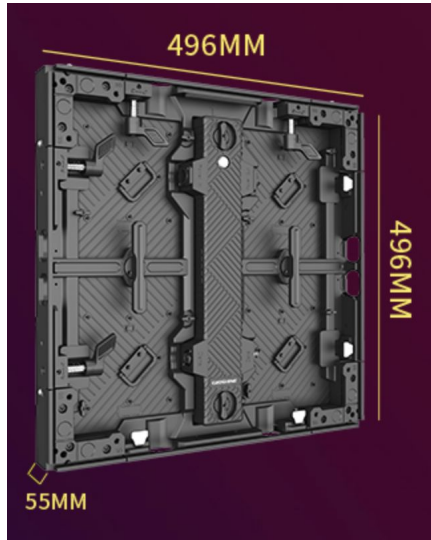

PRODUCT SPECS :

Led P1.5
496 x 496
Novastar

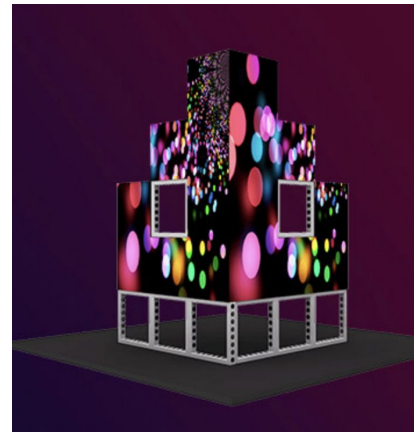

DRY HIRE : NO - Only with Expovision Crew

RM PRODUCT CODE : LED496

RENTAL PRICE : *Price on demand*

CATEGORY : VIDEO & IT

LED 3D effect Production



PRODUCT SPECS :

3D content production a la carte

Led P1.5

Tiles 496 x 496

Novastar Controlling

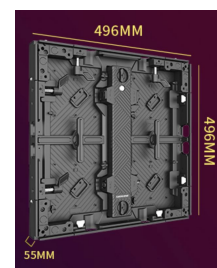

DRY HIRE : NO - Only with Expovision Crew

RM PRODUCT CODE : 3DLED496

RENTAL PRICE : *Price on demand*

CATEGORY : VIDEO & IT

Robotic Display System



PRODUCT SPECS :

Robotic Display System
High-end productions
Art installations, fashion, events, or brand activations
Kuka Robots

DRY HIRE : NO - Only with Expovision Crew

RM PRODUCT CODE : RDS4

RENTAL PRICE : *Price on demand*

CATEGORY : VIDEO & IT

LED Wall P3.9



PRODUCT SPECS :

P3.9 Led wall
Outdoor
Novastar



DRY HIRE : NO - Only with Expovision Crew

RM PRODUCT CODE : LEDWALL39

RENTAL PRICE : Prijs vanaf 180,00 /M2

CATEGORY : VIDEO & IT

LED TV Display 's



PRODUCT SPECS :

- 27" - 75,00
- 32" - 75,00
- 43" - 125,00
- 46" - 150,00
- 50" - 175,00
- 55" - 200,00
- 60" - 225,00
- 65" - 250,00
- 75" - 325,00
- 85" - 550,00

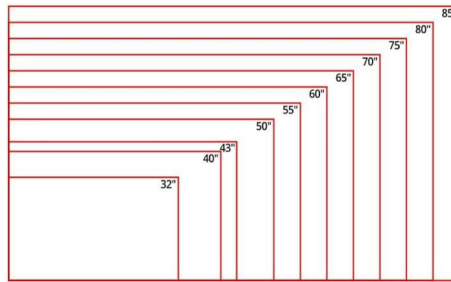

Size	Width	Height	Area
32"	27.9"	15.7"	438 in ²
	70.9 cm	39.9 cm	0.283 m ²
40"	34.9"	19.6"	684 in ²
	88.6 cm	49.8 cm	0.441 m ²
43"	37.5"	21.1"	791 in ²
	95.3 cm	53.6 cm	0.511 m ²
50"	43.6"	24.5"	1068 in ²
	110.7 cm	62.2 cm	0.689 m ²
55"	47.9"	27"	1293 in ²
	121.7 cm	68.6 cm	0.835 m ²
60"	52.3"	29.4"	1538 in ²
	132.8 cm	74.7 cm	0.992 m ²
65"	56.7"	31.9"	1809 in ²
	144 cm	81 cm	1.166 m ²
70"	61"	34.3"	2092 in ²
	154.9 cm	87.1 cm	1.349 m ²
75"	65.4"	36.8"	2407 in ²
	166.1 cm	93.5 cm	1.553 m ²
80"	69.7"	39.2"	2732 in ²
	177 cm	99.6 cm	1.763 m ²
85"	74.1"	41.7"	3090 in ²
	188.2 cm	105.9 cm	1.993 m ²

DRY HIRE : YES

RM PRODUCT CODE : TV27, TV32 ,..... ,TV85

RENTAL PRICE : 75,00 → 550,00

option TV stand 30,00

CATEGORY : VIDEO & IT

I-Pad in tafel statief Apple



PRODUCT SPECS :

Horizontal or vertical use.
Safety Lock Cable



DRY HIRE : YES

RM PRODUCT CODE :

RENTAL PRICE : 50,00

HDMI switch Extron



PRODUCT SPECS :

EXTRON
HD - 4K switch voor 2 HDMI bronnen.

SW2 HD 4K

DRY HIRE : YES

RM PRODUCT CODE :

RENTAL PRICE : 25,00

CATEGORY : VIDEO & IT

HDMI to SDI Converter Black Magic design



PRODUCT SPECS :

Bi directional convertor HDMI to SDI

DRY HIRE : YES

RM PRODUCT CODE :

RENTAL PRICE : 15,00

Beamer 4K - 4000 Lummen Optoma



PRODUCT SPECS :

4000 Ansi Lumen
4K
Normal Throw

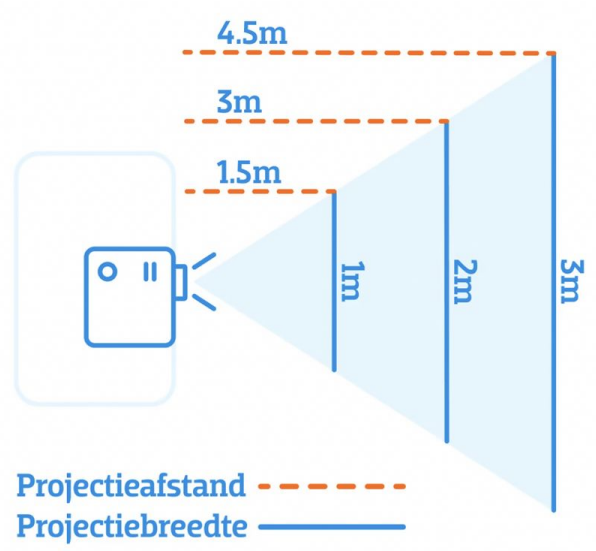

DRY HIRE : YES

RM PRODUCT CODE :

RENTAL PRICE : 200,00

Camera Statief MARK4GSCF Camgear



PRODUCT SPECS :

Camera Statief

DRY HIRE : YES

RM PRODUCT CODE :

RENTAL PRICE : 50,00

CATEGORY : VIDEO & IT

PTZ - Camera VC-G30 Lumens



PRODUCT SPECS :

Camera
Pan/Tilt/Zoom camera + remote
15 x Optical Zoom
Full HD
Remote Control

DRY HIRE : YES

RM PRODUCT CODE :

RENTAL PRICE : 125,00

CATEGORY : VIDEO & IT

EXPOVISION

EXPVISION

TRUSSING
& RIGGING

*Our range is constantly
expanding, if there are
things you don't see,
please ask and we will
see how we can help you.*

H30V-029 BLACK
PROLYTE

NX34-029 BLACK
NEXT



PRODUCT SPECS :

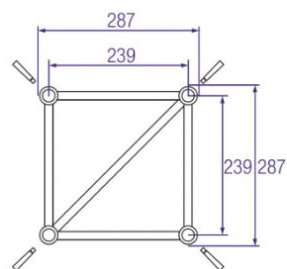

DRY HIRE : YES

RM PRODUCT CODE :

RENTAL PRICE : 8,00

CATEGORY : TRUSSING

H30V-050 BLACK
PROLYTE

NX34-050 BLACK
NEXT



PRODUCT SPECS :

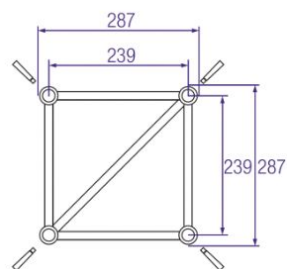

DRY HIRE : YES

RM PRODUCT CODE :

RENTAL PRICE : 8,00

CATEGORY : TRUSSING

H30V-071 BLACK
PROLYTE

NX34-071 BLACK
NEXT



PRODUCT SPECS :

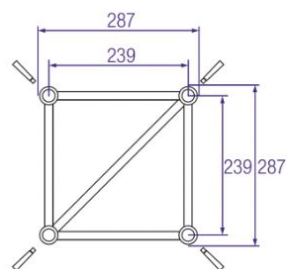

DRY HIRE : YES

RM PRODUCT CODE :

RENTAL PRICE : 8,00

CATEGORY : TRUSSING

H30V-100 BLACK
PROLYTE

NX34-100 BLACK
NEXT



PRODUCT SPECS :

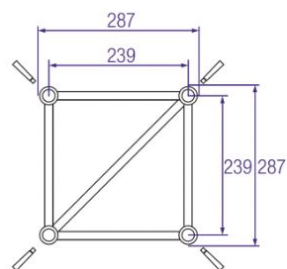

DRY HIRE : YES

RM PRODUCT CODE :

RENTAL PRICE : 8,00

CATEGORY : TRUSSING

H30V-200 BLACK
PROLYTE

NX34-200 BLACK
NEXT



PRODUCT SPECS :

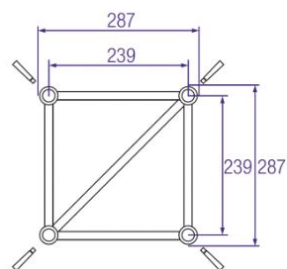

DRY HIRE : YES

RM PRODUCT CODE :

RENTAL PRICE : 13,00

CATEGORY : TRUSSING

H30V-300 BLACK
PROLYTE

NX34-300 BLACK
NEXT



PRODUCT SPECS :

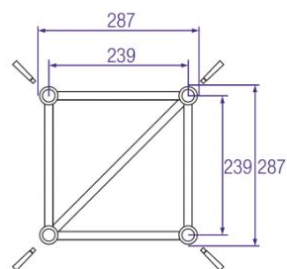

DRY HIRE : YES

RM PRODUCT CODE :

RENTAL PRICE : 19,00

CATEGORY : TRUSSING

H30V-C003 BLACK
PROLYTE

NX34-L90 BLACK
NEXT

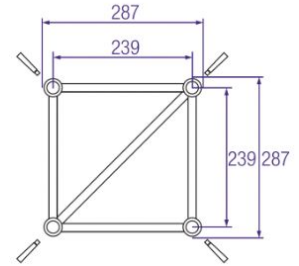
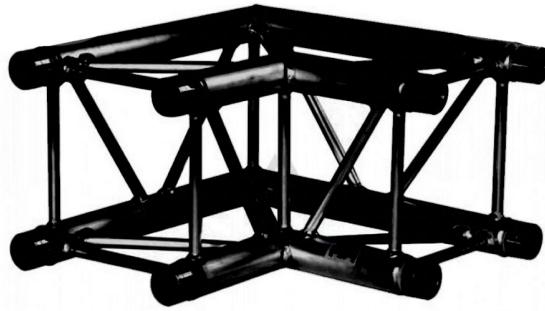

PRODUCT SPECS :



H30V-C003 2-Way
Corner 90°

Next : NH34-L90



H30V-C017 3-Way Corner
T-Joint

Next : NH34-T



H30V-C016 4-Way
Corner Cross

Next : NH34-X



H30V-C012 3-Way Corner

Next ; NH34-L90D



H30V-C020 4-Way
Corner

Next : NH34-TD



H30V-C024 5-Way
Corner

Next : NH34-XD

DRY HIRE : YES

RM PRODUCT CODE :

RENTAL PRICE : 13,00

CATEGORY : TRUSSING

H30V-C017 BLACK
PROLYTE

NX34-T BLACK
NEXT

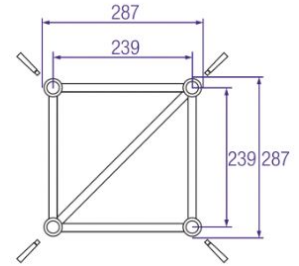

PRODUCT SPECS :



**H30V-C003 2-Way
Corner 90°**

Next : NH34-L90



**H30V-C017 3-Way Corner
T-Joint**

Next : NH34-T



**H30V-C016 4-Way
Corner Cross**

Next : NH34-X



H30V-C012 3-Way Corner

Next ; NH34-L90D



**H30V-C020 4-Way
Corner**

Next : NH34-TD



**H30V-C024 5-Way
Corner**

Next : NH34-XD

DRY HIRE : YES

RM PRODUCT CODE :

RENTAL PRICE : 16,00

CATEGORY : TRUSSING

H30V-C016 BLACK
PROLYTE

NX34-X BLACK
NEXT

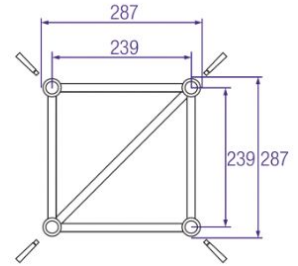

PRODUCT SPECS :



H30V-C003 2-Way
Corner 90°

Next : NH34-L90



H30V-C017 3-Way Corner
T-Joint

Next : NH34-T



H30V-C016 4-Way
Corner Cross

Next : NH34-X



H30V-C012 3-Way Corner

Next ; NH34-L90D



H30V-C020 4-Way
Corner

Next : NH34-TD



H30V-C024 5-Way
Corner

Next : NH34-XD

DRY HIRE : YES

RM PRODUCT CODE :

RENTAL PRICE : 16,00

CATEGORY : TRUSSING

H30V-C012 BLACK
PROLYTE

NX34-L90D BLACK
NEXT

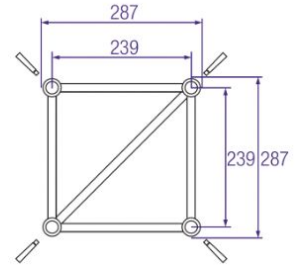

PRODUCT SPECS :



H30V-C003 2-Way
Corner 90°

Next : NH34-L90



H30V-C017 3-Way Corner
T-Joint

Next : NH34-T



H30V-C016 4-Way
Corner Cross

Next : NH34-X



H30V-C012 3-Way Corner

Next ; NH34-L90D



H30V-C020 4-Way
Corner

Next : NH34-TD



H30V-C024 5-Way
Corner

Next : NH34-XD

DRY HIRE : YES

RM PRODUCT CODE :

RENTAL PRICE : 16,00

CATEGORY : TRUSSING

H30V-C020 BLACK
PROLYTE

NX34-TD BLACK
NEXT

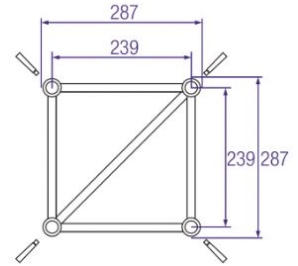

PRODUCT SPECS :



H30V-C003 2-Way
Corner 90°

Next : NH34-L90



H30V-C017 3-Way Corner
T-Joint

Next : NH34-T



H30V-C016 4-Way
Corner Cross

Next : NH34-X



H30V-C012 3-Way Corner

Next ; NH34-L90D



H30V-C020 4-Way
Corner

Next : NH34-TD



H30V-C024 5-Way
Corner

Next : NH34-XD

DRY HIRE : YES

RM PRODUCT CODE :

RENTAL PRICE : 19,50

CATEGORY : TRUSSING

H30V-C024 BLACK
PROLYTE

NX34-XD BLACK
NEXT

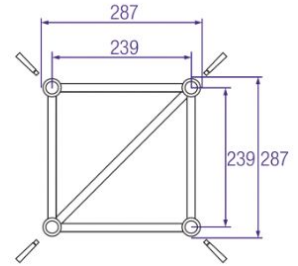

PRODUCT SPECS :



**H30V-C003 2-Way
Corner 90°**

Next : NH34-L90



**H30V-C017 3-Way Corner
T-Joint**

Next : NH34-T



**H30V-C016 4-Way
Corner Cross**

Next : NH34-X



H30V-C012 3-Way Corner

Next ; NH34-L90D



**H30V-C020 4-Way
Corner**

Next : NH34-TD



**H30V-C024 5-Way
Corner**

Next : NH34-XD

DRY HIRE : YES

RM PRODUCT CODE :

RENTAL PRICE : 19,50

CATEGORY : TRUSSING

H30V 29 / 50 / 71 / 100 cm PROLYTE / NEXT



H30V-029

next code: NX34-029

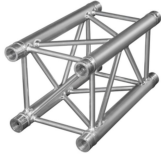

H30V-050

next code: NX34-050



H30V-071

next code: NX34-051

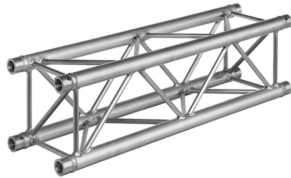

H30V-100

next code: NX43-100

PRODUCT SPECS :

Heavy Duty Truss

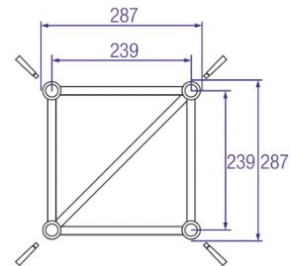

DRY HIRE : YES

RM PRODUCT CODE : H30V-....

RENTAL PRICE : 5,50

CATEGORY : TRUSSING

H30V-200
PROLYTE

NX34-200
NEXT

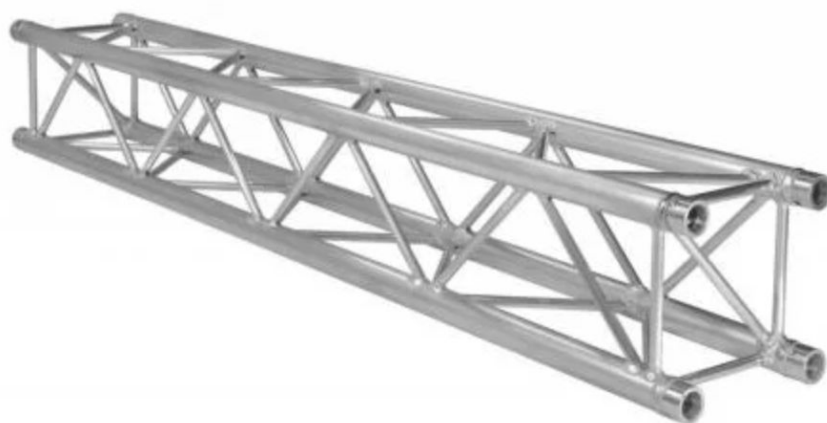

PRODUCT SPECS :

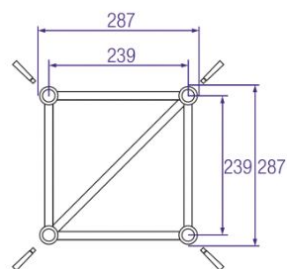

DRY HIRE : YES

RM PRODUCT CODE : TH30V200S

RENTAL PRICE : 8,75

CATEGORY : TRUSSING

H30V-300
PROLYTE

NX34-300
NEXT

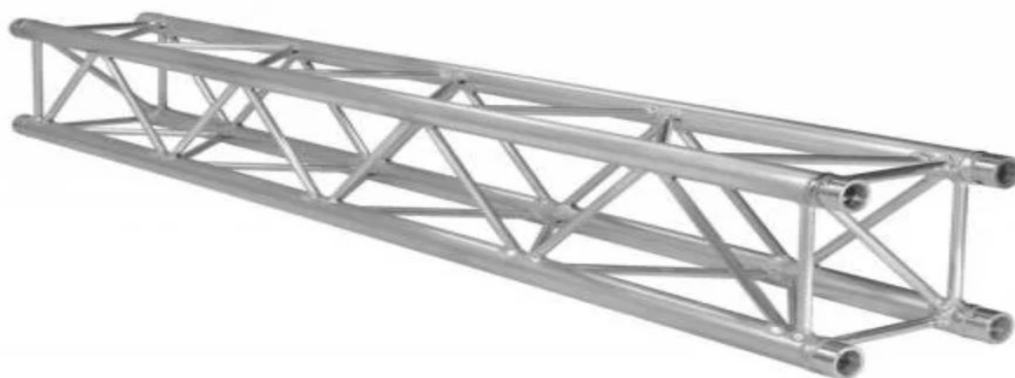

PRODUCT SPECS :

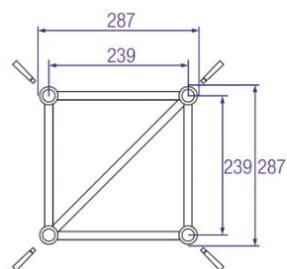

DRY HIRE : YES

RM PRODUCT CODE : TH30V300S

RENTAL PRICE : 13,00

CATEGORY : TRUSSING

H30V-C003
PROLYTE

NX34-L90
NEXT

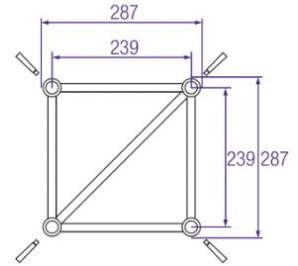

PRODUCT SPECS :



**H30V-C003 2-Way
Corner 90°**

Next : NH34-L90



**H30V-C017 3-Way Corner
T-Joint**

Next : NH34-T



**H30V-C016 4-Way
Corner Cross**

Next : NH34-X



**H30V-C012 3-Way
Corner**

Next ; NH34-L90D



**H30V-C020 4-Way
Corner**

Next : NH34-TD



**H30V-C024 5-Way
Corner**

Next : NH34-XD

DRY HIRE : YES

RM PRODUCT CODE :

RENTAL PRICE : 11,00

CATEGORY : TRUSSING

H30V-C017
PROLYTE

NX34-T
NEXT

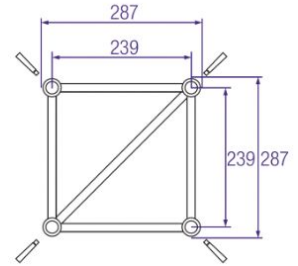
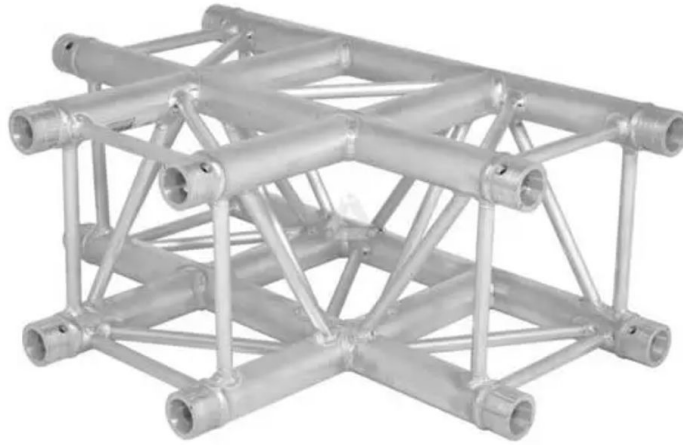

PRODUCT SPECS :



**H30V-C003 2-Way
Corner 90°**

Next : NH34-L90



**H30V-C017 3-Way Corner
T-Joint**

Next : NH34-T



**H30V-C016 4-Way
Corner Cross**

Next : NH34-X



H30V-C012 3-Way Corner

Next ; NH34-L90D



**H30V-C020 4-Way
Corner**

Next : NH34-TD



**H30V-C024 5-Way
Corner**

Next : NH34-XD

DRY HIRE : YES

RM PRODUCT CODE :

RENTAL PRICE : 13,75

CATEGORY : TRUSSING

H30V-C016
PROLYTE

NX34-X
NEXT

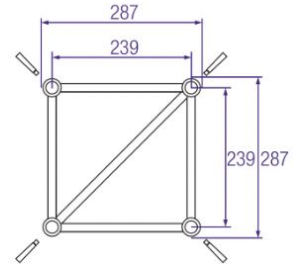
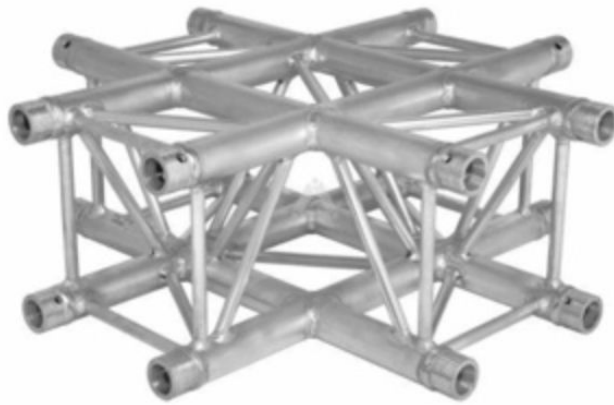

PRODUCT SPECS :



**H30V-C003 2-Way
Corner 90°**

Next : NH34-L90



**H30V-C017 3-Way Corner
T-Joint**

Next : NH34-T



**H30V-C016 4-Way
Corner Cross**

Next : NH34-X



H30V-C012 3-Way Corner

Next ; NH34-L90D



**H30V-C020 4-Way
Corner**

Next : NH34-TD



**H30V-C024 5-Way
Corner**

Next : NH34-XD

DRY HIRE : YES

RM PRODUCT CODE :

RENTAL PRICE : 13,75

CATEGORY : TRUSSING

H30V-C012
PROLYTE

NX34-L90D
NEXT

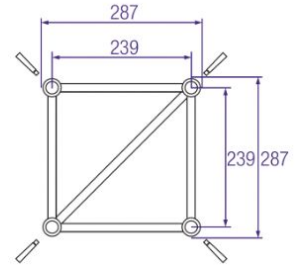
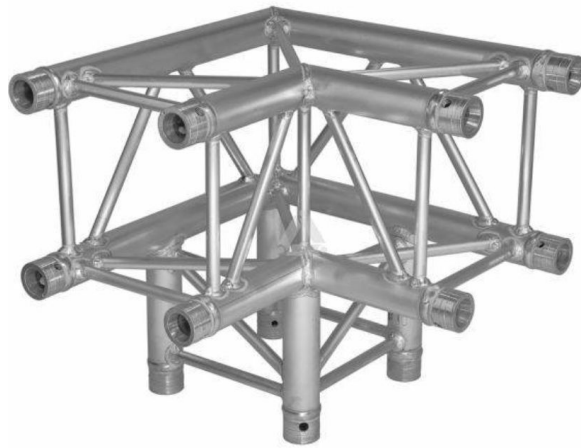

PRODUCT SPECS :



**H30V-C003 2-Way
Corner 90°**

Next : NH34-L90



**H30V-C017 3-Way Corner
T-Joint**

Next : NH34-T



**H30V-C016 4-Way
Corner Cross**

Next : NH34-X



**H30V-C012 3-Way
Corner**

Next ; NH34-L90D



**H30V-C020 4-Way
Corner**

Next : NH34-TD



**H30V-C024 5-Way
Corner**

Next : NH34-XD

DRY HIRE : YES

RM PRODUCT CODE :

RENTAL PRICE : 13,75

CATEGORY : TRUSSING

H30V-C020
PROLYTE

NX34-TD
NEXT

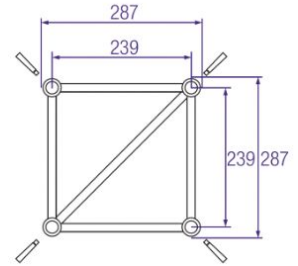

PRODUCT SPECS :



**H30V-C003 2-Way
Corner 90°**

Next : NH34-L90



**H30V-C017 3-Way Corner
T-Joint**

Next : NH34-T



**H30V-C016 4-Way
Corner Cross**

Next : NH34-X



H30V-C012 3-Way Corner

Next ; NH34-L90D



**H30V-C020 4-Way
Corner**

Next : NH34-TD



**H30V-C024 5-Way
Corner**

Next : NH34-XD

DRY HIRE : YES

RM PRODUCT CODE :

RENTAL PRICE : 16,50

CATEGORY : TRUSSING

H30V-C024
PROLYTE

NX34-XD
NEXT

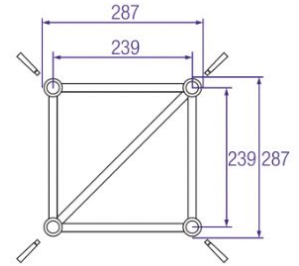
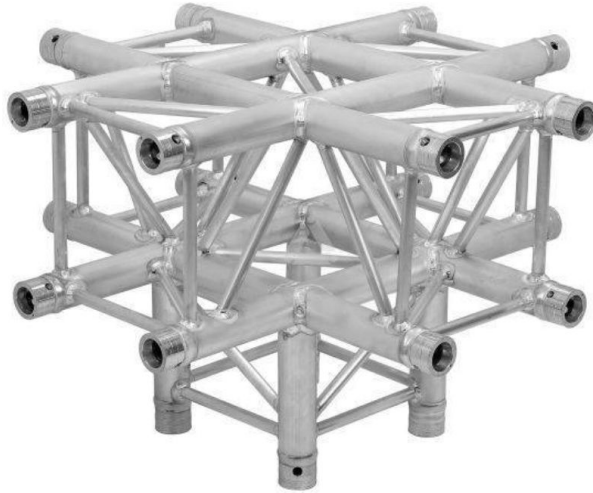

PRODUCT SPECS :



**H30V-C003 2-Way
Corner 90°**

Next : NH34-L90



**H30V-C017 3-Way Corner
T-Joint**

Next : NH34-T



**H30V-C016 4-Way
Corner Cross**

Next : NH34-X



H30V-C012 3-Way Corner

Next ; NH34-L90D



**H30V-C020 4-Way
Corner**

Next : NH34-TD



**H30V-C024 5-Way
Corner**

Next : NH34-XD

DRY HIRE : YES

RM PRODUCT CODE :

RENTAL PRICE : 16,50

CATEGORY : TRUSSING

X30-D SILVER & BLACK
PROLYTE

NX33-X SILVER & BLACK
NEXT

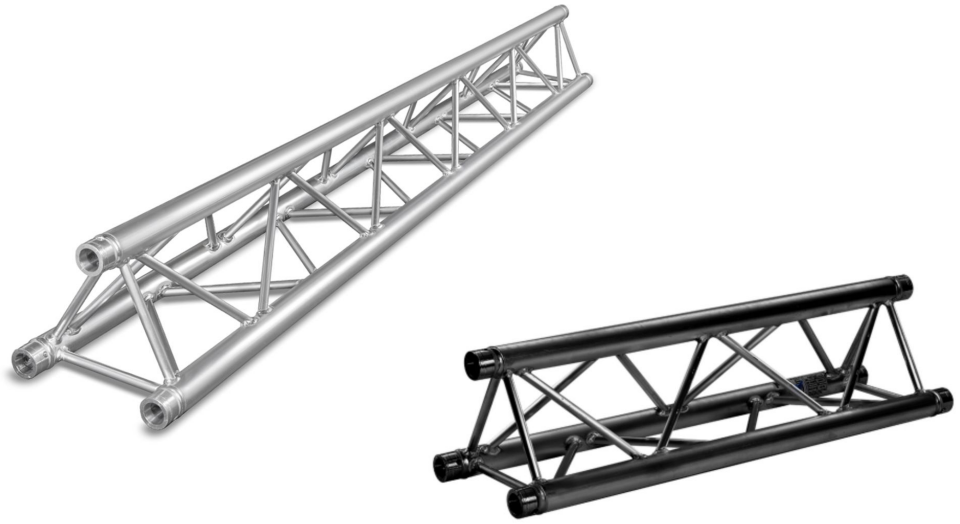

PRODUCT SPECS :

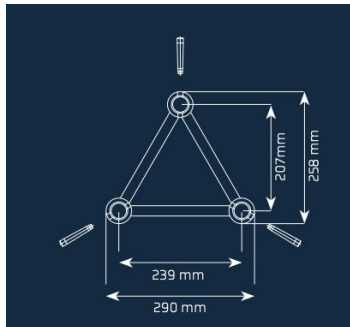

All lengths & corners on demand

DRY HIRE : YES

RM PRODUCT CODE :

RENTAL PRICE : Price on demand

CATEGORY : TRUSSING

LEGM290V | 572-950 Adjustable pedestal leg 57



PRODUCT SPECS :

Adjustable pedestal leg 572-950mm

Compatible for PROLYTE X30-V H30-V , NEXT NX34 and Milos F-type

7,7 kg

Milos

DRY HIRE : YES

RM PRODUCT CODE :

RENTAL PRICE : 17,50

CATEGORY : TRUSSING

BOOK CORNER PROLYTE



PRODUCT SPECS :

Book Corner for H30V en X30 series

DRY HIRE : YES

RM PRODUCT CODE :

RENTAL PRICE : Price on demand

CATEGORY : TRUSSING

PINCASE 200
PROLYTE

PINCASE 200
NEXT

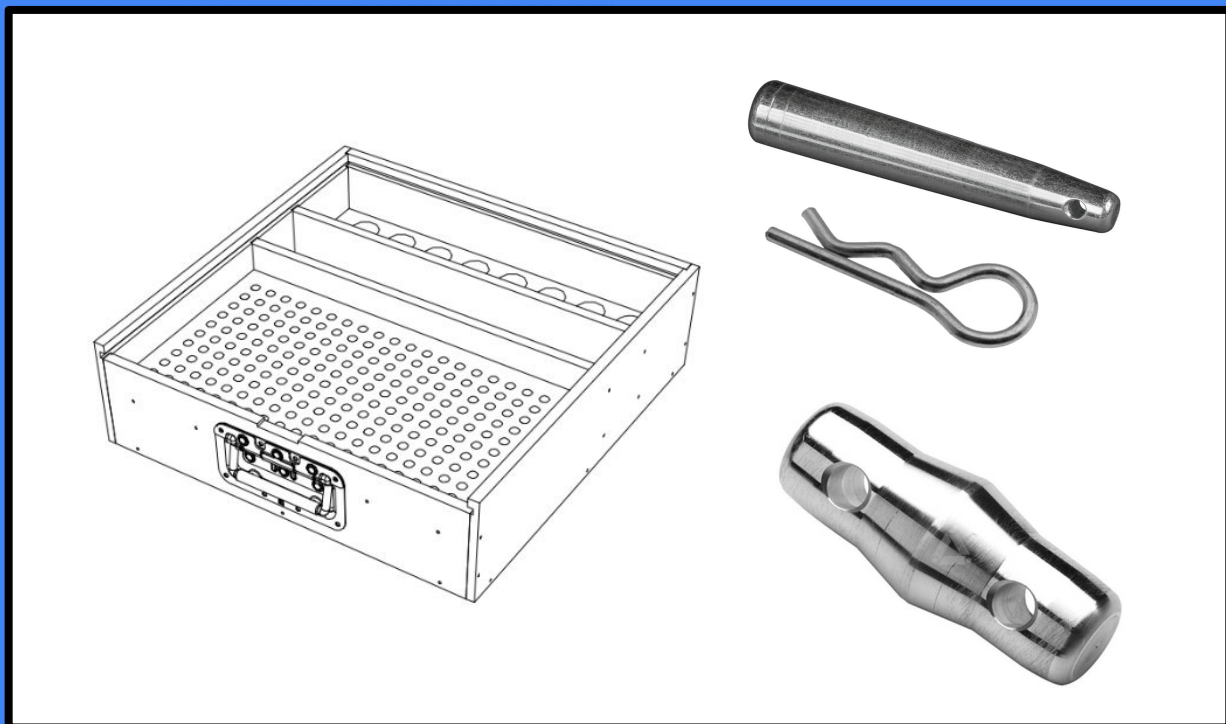

PRODUCT SPECS :

200x pins & clips
16x conical coupler

DRY HIRE : YES

RM PRODUCT CODE :

RENTAL PRICE : 20,00

CATEGORY : TRUSSING

ALU PIPE 48mm Black



PRODUCT SPECS :

Black ALU pipe 0,5m / 1m / 2m / 3m / 4m / 5m / 6m

DRY HIRE : YES

RM PRODUCT CODE :

RENTAL PRICE : 1,50 / lopende meter

CATEGORY : TRUSSING

Downrigger

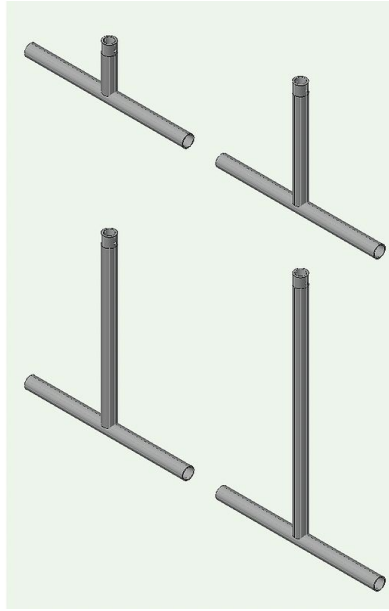

PRODUCT SPECS :

Downrigger 25 - 50 - 75 - 100 cm
+ C-clamp with half coupler
B = 65 cm

DRY HIRE : YES

RM PRODUCT CODE :

RENTAL PRICE : 7,50 / pcs

CATEGORY : TRUSSING

MPT - TOWER PROLYTE



PRODUCT SPECS :

The MPT tower is based on H30V truss and employs a sleeve block that fits to any of the 30 or 40 Series trusses on all four sides by means of bolted CCS6 couplers (either male or female). In combination with an adapter plate, it is also possible to use the sleeve block with either S36R or S36V truss. The MPT tower has a self-weight of 115 kg. The MPT sleeve block is a fully bolted structural element, making it much stronger and more precise than conventional welded versions. The top section and base section can facilitate the use of either a hand winch or a chain hoist. The MPT tower is a cost-effective investment. You need only purchase the special parts if you wish to expand your truss system with towers.

DRY HIRE : NO - Only with Expovision crew

RM PRODUCT CODE :

RENTAL PRICE : Price on demand

CATEGORY : TRUSSING

BASEPLATE Prolyte / Next



PRODUCT SPECS :

- 100 x 100 CM
- 40 kg

DRY HIRE : YES

RM PRODUCT CODE :

RENTAL PRICE : 11,00

CATEGORY : TRUSSING

TENTCLAMP - max.150kg DAP



PRODUCT SPECS :

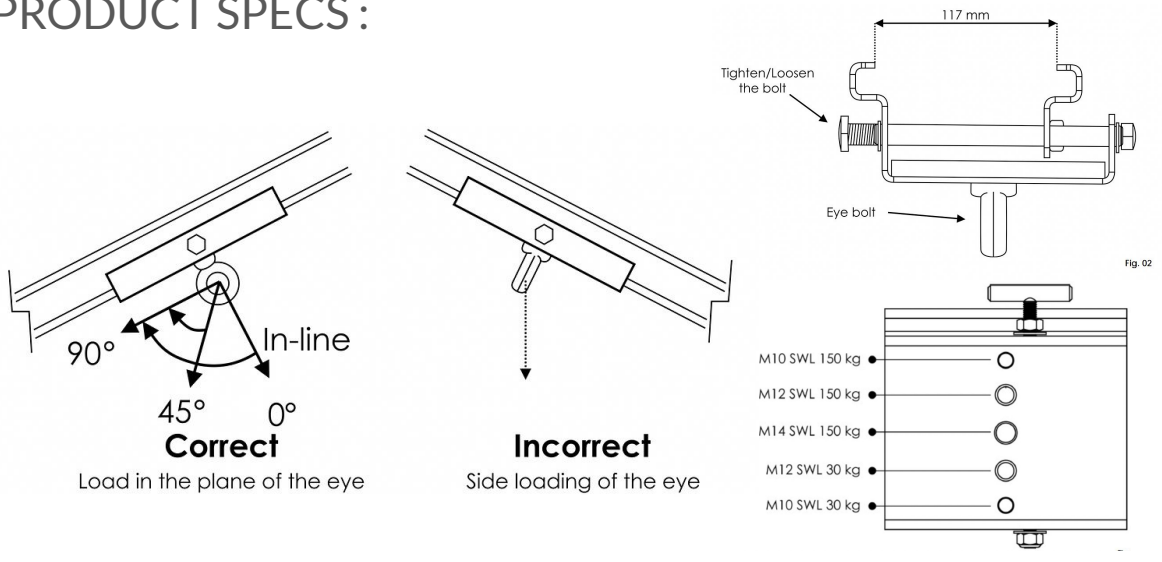

DRY HIRE : YES

RM PRODUCT CODE :

RENTAL PRICE : 10,00

CATEGORY : RIGGING

DOUBLE C-CLAMP

Doughty



PRODUCT SPECS :

- available in silver or black
- fits all truss

DRY HIRE : YES

RM PRODUCT CODE :

RENTAL PRICE : 3,00

CATEGORY : RIGGING

MANUAL HOIST

SOFT STEEL + HARP



PRODUCT SPECS :

Manual hoist 500kg

Soft Steel
+ harp 3.5 ton

DRY HIRE : YES

RM PRODUCT CODE :

RENTAL PRICE : 20,00 / 3,00

CATEGORY : RIGGING

EXPOVISION

EXPVISION

**WORK LIFTS
& TRIPODS**

*Our range is constantly
expanding, if there are
things you don't see,
please ask and we will
see how we can help you.*

Wind-up Manfrotto



PRODUCT SPECS :

Heavy-duty lighting stand with 370 cm max height · Levelling leg for uneven terrain · Made of durable black chrome steel

DRY HIRE : YES

RM PRODUCT CODE :

RENTAL PRICE : 15,00

CATEGORY : TRIPODS

BALLET TOREN Expovision



PRODUCT SPECS :

- Uitschuifbare Ballettoren met 4 rijen.
- Uitschuifbaar in verschillende standen.
- Verstelbare buizen.
- Op wielen met rem , kan heel snel op en af een podium.
- Voorzien van verzwaarde base voor stabiliteit.

DRY HIRE : YES

RM PRODUCT CODE :

RENTAL PRICE : 70,00

CATEGORY : BALLET TOREN

LIFT LM 450 - 250 kg ALP



PRODUCT SPECS :

Up to 4,5 m

Max. 250 kg



DRY HIRE : YES

RM PRODUCT CODE : LALPLM450

RENTAL PRICE : 45,00

CATEGORY : WORK LIFTS

LIFT LM 750 - 300 kg ALP



PRODUCT SPECS :

Up to 7,5 m

Max. 300 kg



DRY HIRE : YES

RM PRODUCT CODE : LALPLM750

RENTAL PRICE : 55,00

CATEGORY : WORK LIFTS

LIFT L476 - 350 kg
ALP

NEW



PRODUCT SPECS :

Hefhoogte: 4.76 meter
Max. 350 kg

Ingeschoven hoogte: 1,87 meter

Eigen gewicht: 143 kg

DRY HIRE : YES

RM PRODUCT CODE : LALPL476

RENTAL PRICE : 55,00

CATEGORY : WORK LIFTS

LIFT L512 - 350 kg ALP

NEW



PRODUCT SPECS :

Hefhoogte: 5,12 meter
Max. 350 kg

Transporthoogte: 1,60 meter

Eigen gewicht: 153 kg.

DRY HIRE : YES

RM PRODUCT CODE : LALPL512

RENTAL PRICE : 55,00

CATEGORY : WORK LIFTS

UP-RIGHT PHC940 ALP



PRODUCT SPECS :

Up to 9,40 m - 1 person

DRY HIRE : YES

RM PRODUCT CODE : LALPPHC940

RENTAL PRICE : 149,00

CATEGORY : PERSON LIFT

SCISSOR LIFT COMPACT 1 Ton Zoomlion



PRODUCT SPECS :

- Schaarhoogtewerker kan getransporteerd worden door de meeste gewone vrachtwagens met een laadklep van 1 ton en dit door laag eigen gewicht , dus er moet geen speciaal vervoer voorzien worden zoals bij de meeste schaarliften.
- Werkhoogte: 6.50 meter
- Hef Capaciteit 240 kg
- Transporthoogte (rails up/down) 2,05/1,70 mtr
- Lengte x breedte 1,44 x 0,76 mtr
- Eigen gewicht 895 kg

DRY HIRE : YES

RM PRODUCT CODE : LSCISCOMP

RENTAL PRICE : 149,00

CATEGORY : SCISSOR LIFT

MOVER 3 Ton V-MOVE XL 1500

NEW



PRODUCT SPECS :

Met de V-move XL 1500 verplaatst U aanhangers of mobiele podia.

- Trek/duw capaciteit tot 5.000kg
- 1 x 1500 Watt elektromotor
- Externe accu lader
- Snelheid traploos regelbaar (0-6 km/h)
- Elektromagnetische parkeerrem
- Accu indicator
- Belly button veiligheidsschakelaar
- Voorzien van alle terrein lucht banden.

DRY HIRE : YES

RM PRODUCT CODE : VMOVEXL

RENTAL PRICE : 125,00

CATEGORY : TOOLS

EXPOVISION

EXPVISION

BOOTH CONSTRUCTION & DECORATION

Staffel Booth Construction category

7 days - 1
14 days - 1,5
21 days - 1,75
28 days - 2

*Our range is constantly
expanding, if there are
things you don't see,
please ask and we will
see how we can help you.*

International Booth construction Expovision



PRODUCT SPECS :

At **Expovision**, we specialize in the design and construction of high-quality modular and hybrid exhibition stands that bring your brand to life at trade shows and exhibitions. From initial concept to final build, our sustainable **Matrix** frame systems enable us to deliver fully integrated, end-to-end solutions that make your stand truly stand out—through innovative design, efficient use of space, and flawless execution.

Our approach is rooted in close collaboration. We work alongside you to fully understand your brand, objectives, and message, ensuring every detail aligns with your vision. Whether you are looking for a sleek and contemporary presentation or a bold, immersive brand experience, we have the expertise to deliver.

Our team of skilled designers and craftsmen combines creativity with technical precision, resulting in exhibition stands that are not only visually striking but also practical, durable, and effective.

Choose **Expovision** for your next exhibition, and together we will create a powerful and lasting impression.

Warehousing Bornem / Belgium

Temporarily store your stand construction or empties



Temporarily store your stand construction or empties. This can always be done by requesting a quote per project.

Expovision - Woestijnstraat 7 - 2880 Bornem

PRODUCT SPECS :

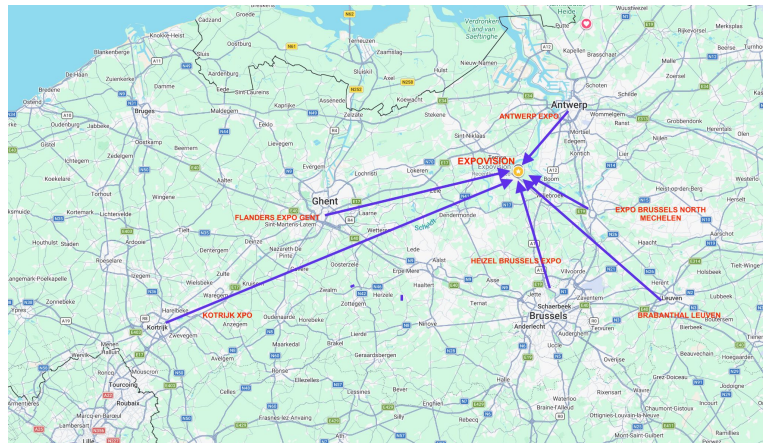

DRY HIRE : YES

RM PRODUCT CODE : Warehousing

RENTAL PRICE : Price on demand

CATEGORY : BOOTH CONSTRUCTION

MATRIXFRAME 55 Aluvision / Matrix Decor

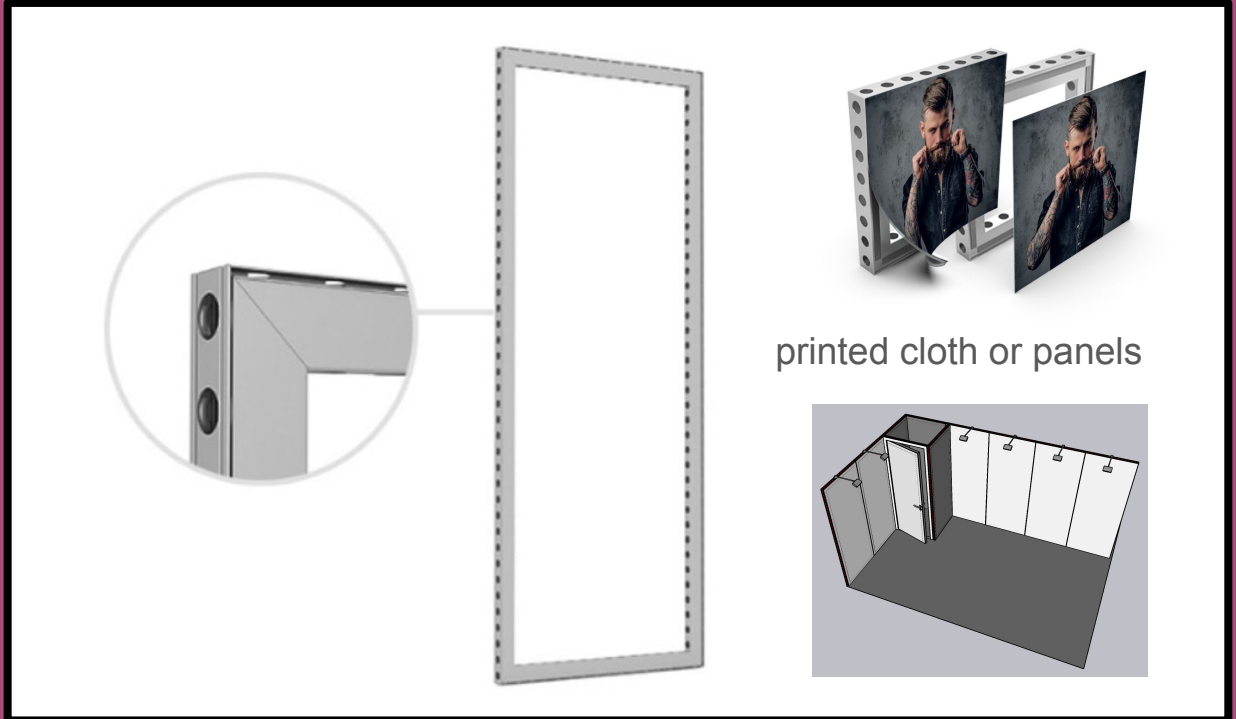

printed cloth or panels

PRODUCT SPECS :

Basic Frames : (without infills)

496 x 496	6,75
496 x 992	8,25
992 x 992	10,50
1488 x 496	9,75
1488 x 992	12,00
1984 x 496	11,25
1984 x 992	13,50
2480 x 496	12,75
2480 x 992	15,00
2976 x 496	14,25
2976 x 992	16,50

CURVED FRAMES : price on demand

Doors : with 1 set forex infills , black or white

Door 992 x 1984	100,00	(with 1 set infills)
Door 992 x 2480	100,00	(with 1 set infills)
Door 992 x 2976	110,00	(with 1 set infills)
<hr/>		
Small Door 868 x 2480	110,00	(with 1 set infills)
<hr/>		
Wide Door 1240 x 2480	120,00	(with 1 set infills)
+ Fit piece up to 2 meter 744	15,00	(with 1 set infills)
<hr/>		
Extra Wide Door 1488 x 2480	150,00	(with 1 set infills)
<hr/>		
Double Door	200,00	(with 1 set infills)

DRY HIRE : YES

RM PRODUCT CODE : M55/ ...

M55/D/...

RENTAL PRICE : See above

CATEGORY : BOOTH CONSTRUCTION

While discounts apply to some of our products, this item is already priced at the best rate and is not eligible for further discounts.

DIBOND / FOREX / CLOTH *Infills for frames*



PRODUCT SPECS :

Forex 3mm

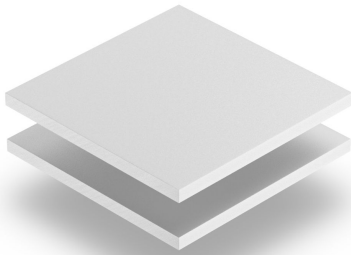

Dibond 3mm

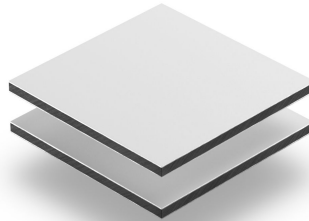

Printed Cloth

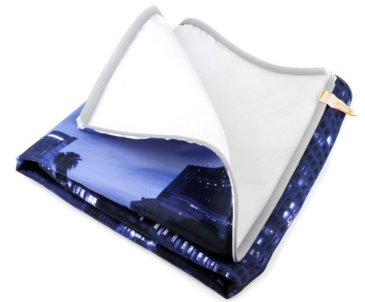

DRY HIRE : YES

RM PRODUCT CODE :

RENTAL PRICE : Price on demand

CATEGORY : BOOTH CONSTRUCTION

Wall mount insert plate attachment Aluvision / Matrix Decor



PRODUCT SPECS :

- Wall mount reinforcement
 - This allows you to mount wooden panels in the frames
- Option:
- Wooden panel 60cm High 7,00 / piece
You need 4 wall mount inserts for 1 panel

DRY HIRE : YES

RM PRODUCT CODE : BIPA

RENTAL PRICE : 0,75 /piece (wooden panel 7,00)

CATEGORY : BOOTH CONSTRUCTION

While discounts apply to some of our products, this item is already priced at the best rate and is not eligible for further discounts.

PENVERBINDER LS30 A

Aluvision

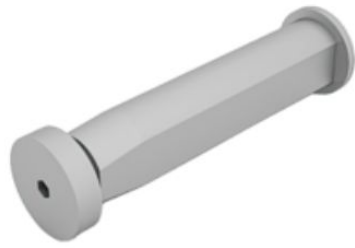

PRODUCT SPECS :

LS D30 A

Quick tightener set

13 cm

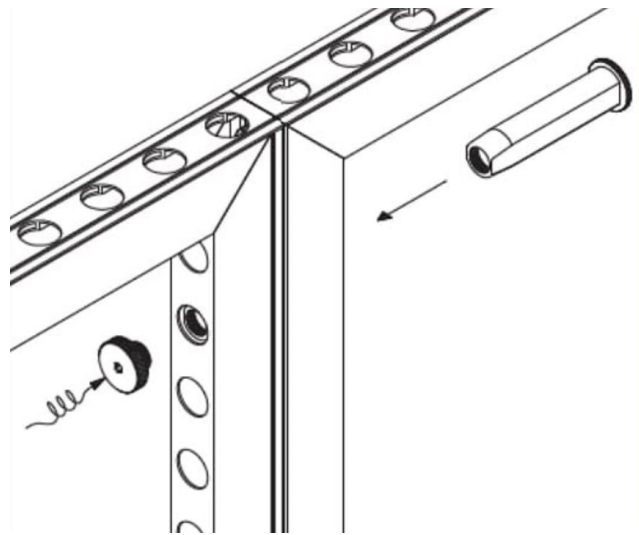

DRY HIRE : YES

RM PRODUCT CODE :

RENTAL PRICE : 1,50

CATEGORY : BOOTH CONSTRUCTION

While discounts apply to some of our products, this item is already priced at the best rate and is not eligible for further discounts.

Screw Connectors Aluvision / Matrix Decor

Screw Connector Standard



Screw Connector Low Head



Screw Connector with Lifting Eye



Double Door Connector



PRODUCT SPECS :

- Screw Connectors

DRY HIRE : YES

RM PRODUCT CODE :

RENTAL PRICE : 1,50

CATEGORY : BOOTH CONSTRUCTION

While discounts apply to some of our products, this item is already priced at the best rate and is not eligible for further discounts.

Flat Connectors Aluvision / Matrix Decor

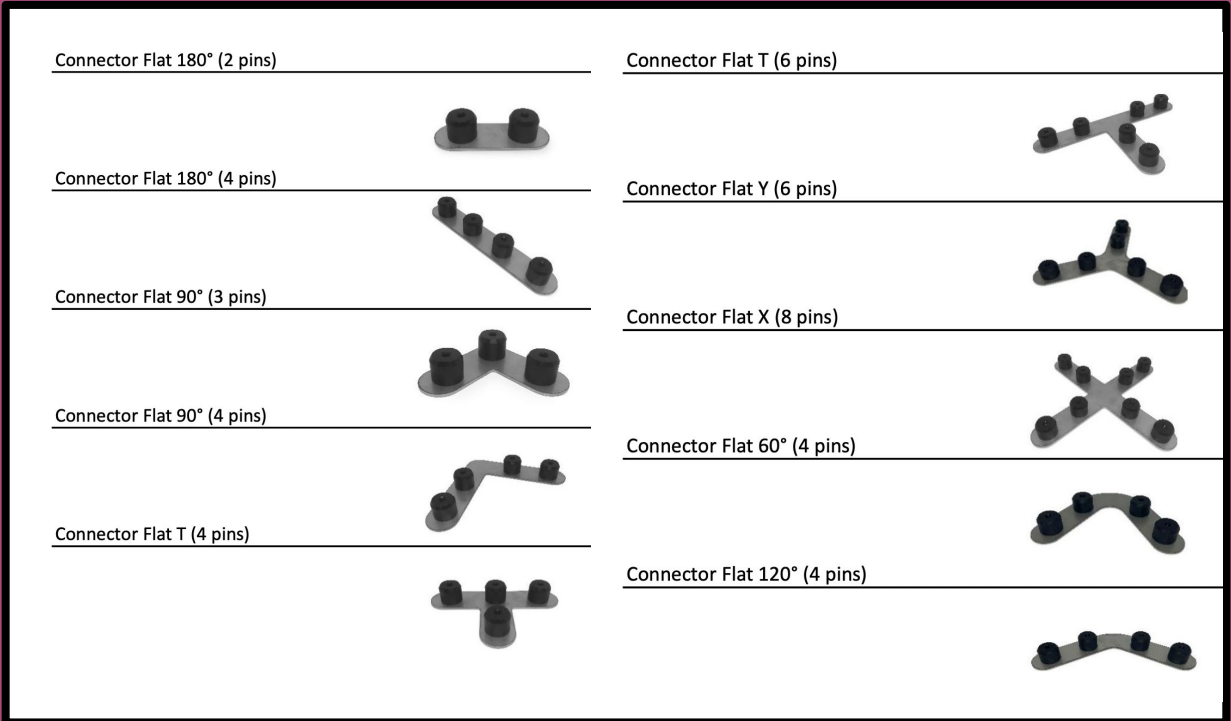

PRODUCT SPECS :

- Flat Connectors

Connector Flat 135° (4 pins)



Connector Flat 150° (4 pins)



Connector Flat 175° (4 pins)



Connector Flat Slidable 90° (3 pins) Left



Connector Flat Slidable 90° (3 pins) Right



DRY HIRE : YES

RM PRODUCT CODE :

RENTAL PRICE : 1,50

CATEGORY : BOOTH CONSTRUCTION

While discounts apply to some of our products, this item is already priced at the best rate and is not eligible for further discounts.

Double Connectors Aluvision / Matrix Decor

Double Connector 180°

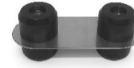

Double Connector 90°



Double Connector T



Double Connector Slidable



Double Connector 90° extra D30 Holes



PRODUCT SPECS :

- Double Connectors

DRY HIRE : YES

RM PRODUCT CODE :

RENTAL PRICE : 1,50

CATEGORY : BOOTH CONSTRUCTION

While discounts apply to some of our products, this item is already priced at the best rate and is not eligible for further discounts.

Angled Connectors Aluvision / Matrix Decor

Angled Connector 90° (2 pins)



Angled Connector 90° (1 pin + D30)



Angled Connector 90° 3mm (2 pins)



Angled Connector 90° 3mm (2 pins + D30)



PRODUCT SPECS :

- Angled Connectors

DRY HIRE : YES

RM PRODUCT CODE :

RENTAL PRICE : 1,50

CATEGORY : BOOTH CONSTRUCTION

While discounts apply to some of our products, this item is already priced at the best rate and is not eligible for further discounts.

Pin Connectors M6 & M8 Aluvision / Matrix Decor

<p>Pin Connector M6</p> <hr/> <p><i>Useful length: 76mm</i></p>		<p>Pin Connector M8 B-Size</p> <hr/> <p><i>Useful length: 64mm</i></p>	
<p>Pin Connector M6 Low</p> <hr/> <p><i>Useful length: 76mm</i></p>		<p>Pin Connector M8 XL</p> <hr/> <p><i>Useful length: 79mm</i></p>	
<p>Pin Connector M8</p> <hr/> <p><i>Useful length: 49mm</i></p>		<p>Pin Connector M8 XXL</p> <hr/> <p><i>Useful length: 89mm</i></p>	
<p>Pin Connector M8 Low</p> <hr/> <p><i>Useful length: 49mm</i></p>			

PRODUCT SPECS :

- Pin Connectors M6 & M8

DRY HIRE : YES

RM PRODUCT CODE :

RENTAL PRICE : 0,50

CATEGORY : BOOTH CONSTRUCTION

While discounts apply to some of our products, this item is already priced at the best rate and is not eligible for further discounts.

Specials Aluvision / Matrix Decor

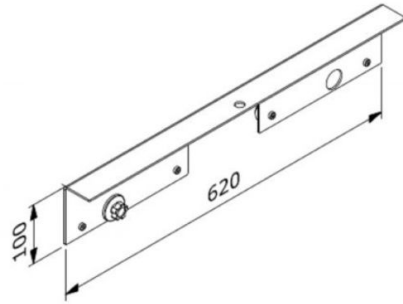

ALUVISION D30 Ceiling reinforcement B

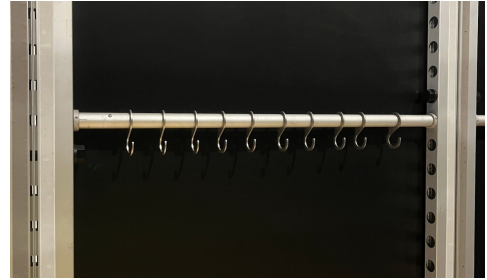

Coat rail with hooks
for 992 frame

PRODUCT SPECS :

DRY HIRE : YES

RM PRODUCT CODE :

RENTAL PRICE : 12,00

CATEGORY : BOOTH CONSTRUCTION

While discounts apply to some of our products, this item is already priced at the best rate and is not eligible for further discounts.

Steel 70cm + Eye connector For matrix frame systems



NEW



PRODUCT SPECS :

STEEL 75cm with safety Ring
PEN with rigging Eye
Load 60kg
6 mm steel



DRY HIRE : YES

RM PRODUCT CODE :

RENTAL PRICE : 4,00

CATEGORY : BOOTH CONSTRUCTION

While discounts apply to some of our products, this item is already priced at the best rate and is not eligible for further discounts.

PUC XL - 50W Aluvision



PRODUCT SPECS :

PUC XL / BLACK
50W - 240V
Select WW or CW
Euronet + euronet link
Select output 50% / 100%



DRY HIRE : YES

RM PRODUCT CODE :

RENTAL PRICE : 25,00

CATEGORY : BOOTH CONSTRUCTION

PUC FLEX Aluvision



PRODUCT SPECS :

PUC FLEX
SILVER
16W - 240V
WW or CW

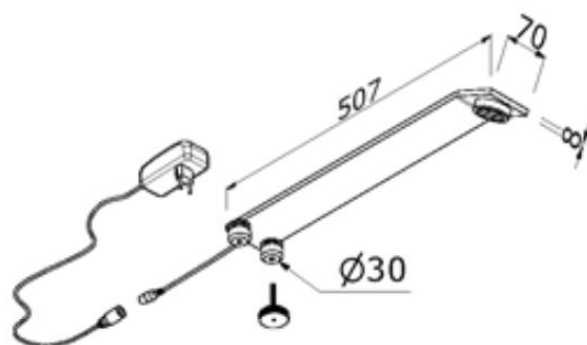

DRY HIRE : YES

RM PRODUCT CODE :

RENTAL PRICE : 25,00

CATEGORY : BOOTH CONSTRUCTION

Matrix ECO Light Silver/Black Expovision



PRODUCT SPECS :

- Black / Warm white
- Silver / Cold white
- 20 Watt
- Matrix Wall Adaptor
- Euro cable

DRY HIRE : YES

RM PRODUCT CODE :

RENTAL PRICE : 15,00

CATEGORY : BOOTH CONSTRUCTION

BASEPLATE MATRIX

for matrix frame

Small BASEPLATE MATRIX

for matrix frame

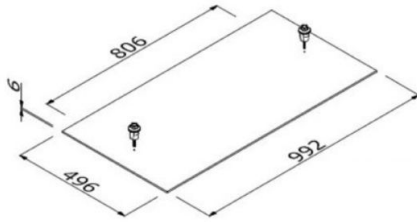

PRODUCT SPECS :

992 x 496 x 6mm

450 x 120 x 6mm

DRY HIRE : YES

RM PRODUCT CODE :

RENTAL PRICE : 15,00 / 6,00

CATEGORY : BOOTH CONSTRUCTION

While discounts apply to some of our products, this item is already priced at the best rate and is not eligible for further discounts.

LOGO BOX Subvision Aluvision



PRODUCT SPECS :

LOGO BOX

From : 0,5 x 0,5 x 0,5 m up to 3 x 3 x 3 m

Available lengths in all directions :

0,5 / 0,75 / 1 / 1,5 / 2 / 2,5 / 3 meter

Every sub box comes with 4 riggings eyes.

Personal prints : price on demand.

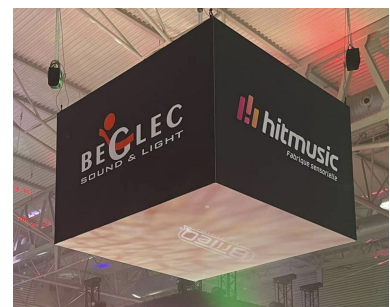

DRY HIRE : YES

RM PRODUCT CODE :

RENTAL PRICE : Price on demand

CATEGORY : BOOTH CONSTRUCTION

Raised Exhibition Floor m2

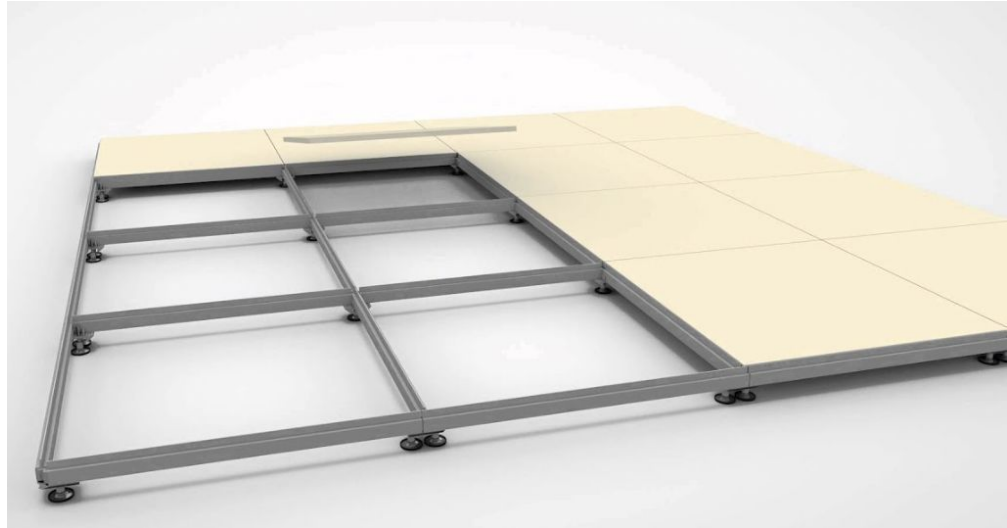

PRODUCT SPECS :

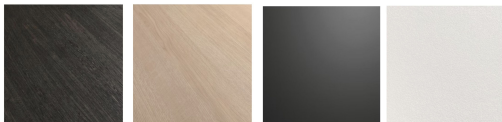
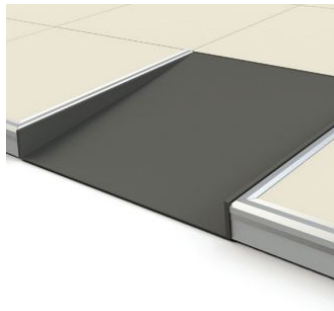

KIVU WENGE
04887 Soft Pearl(CST)

PEARL OAK
04321 Fogmat(BST)

ELEGANT BLACK
0010 Soft Pearl(CST)

FRONT WHITE
0020 Soft Pearl(CST)



DRY HIRE : YES

RM PRODUCT CODE :

RENTAL PRICE : Price & colors on demand

CATEGORY : BOOTH CONSTRUCTION

OSB FLOOR / m2

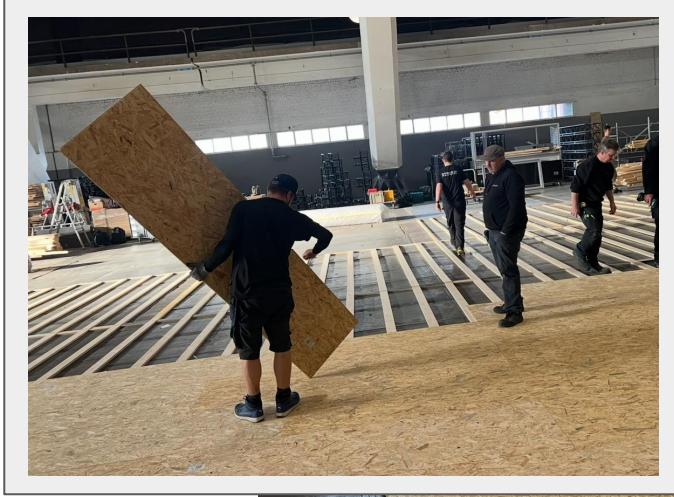

PRODUCT SPECS :

OSB panel Expo Floor

DRY HIRE : NO

RM PRODUCT CODE :

RENTAL PRICE : Price on demand , start at 22,00/m2

CATEGORY : BOOTH CONSTRUCTION

CARPET Exporips



PRODUCT SPECS :

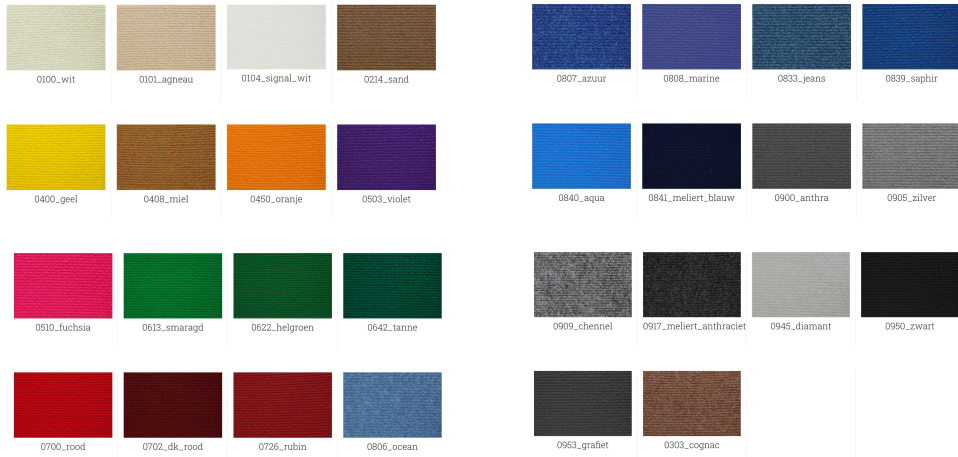

DRY HIRE : YES

RM PRODUCT CODE :

RENTAL PRICE : Price on demand

CATEGORY : BOOTH CONSTRUCTION & DECORATION

PIPE & DRAPE KIT - 24 M Showtex

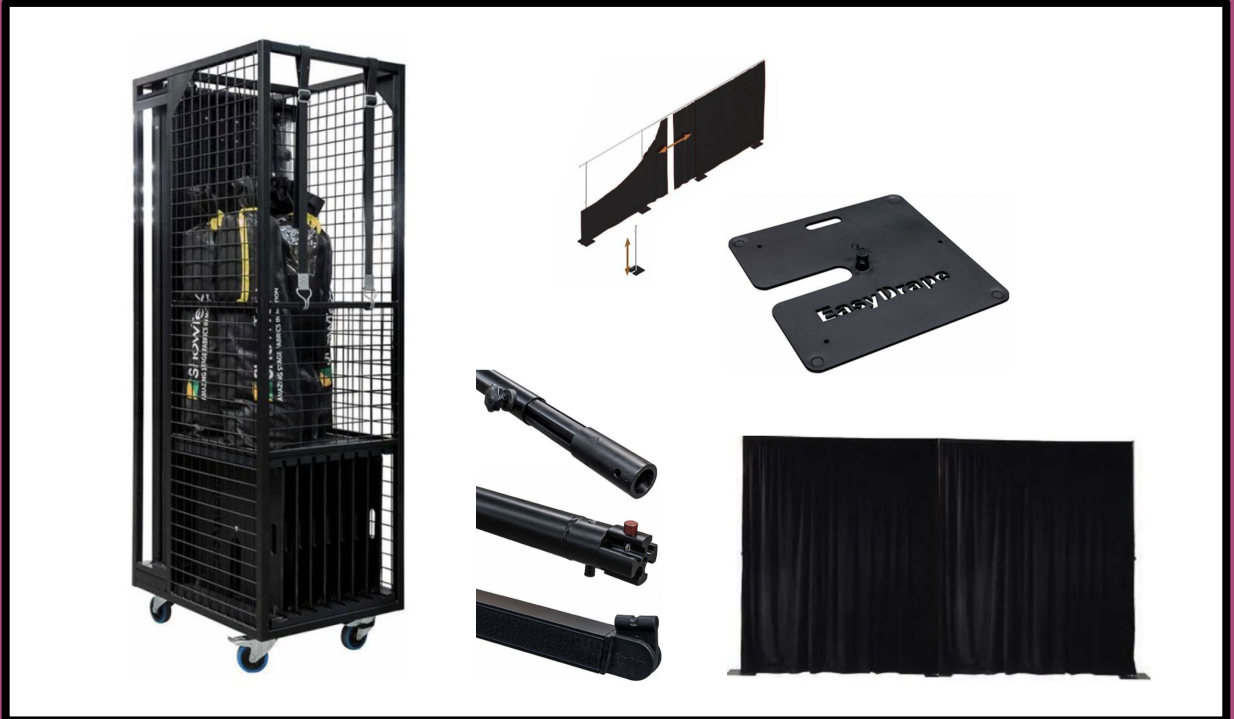

PRODUCT SPECS :

8 x BASE + Stand : 1.80 tot 2,5m H max.

8 x crossbar : 1,8 -> 3 m Wide max.

6 x Curtain : 250H x 400 cm BLACK

Molton CS

Category M1

DRY HIRE : YES

RM PRODUCT CODE : BPDK24

RENTAL PRICE : 360,00

CATEGORY : BOOTH CONSTRUCTION & DECORATION

BACKDROP BLACK Showtex



PRODUCT SPECS :

Backdrop Black Molton
Fire Retardant
300 g/m²

DRY HIRE : YES

RM PRODUCT CODE :

RENTAL PRICE : Rent 5,00 / m² New Made 10,00 / m²

CATEGORY : BOOTH CONSTRUCTION & DECORATION

Ceiling cloth (black / white) Showtex



PRODUCT SPECS :

Molton
Fire Retardant
300 g/m²

DRY HIRE : YES

RM PRODUCT CODE :

RENTAL PRICE : 10,00 / m²

DECOMOLTON Showtex



PRODUCT SPECS :

NFP-M1 / BS-2B
140 g/m²

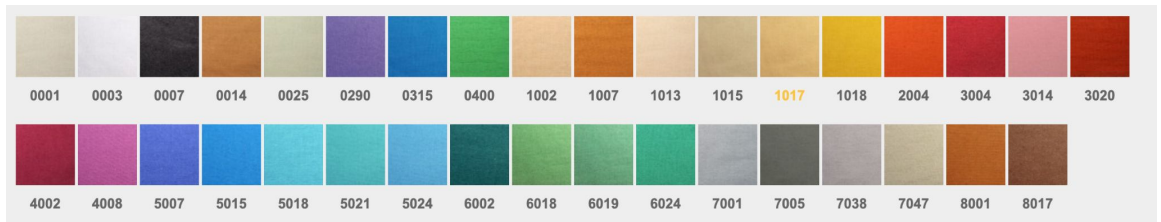

DRY HIRE : YES

RM PRODUCT CODE :

RENTAL PRICE : Price on demand

CATEGORY : BOOTH CONSTRUCTION & DECORATION

Afzetpaal met koord Expovision



PRODUCT SPECS :



DRY HIRE : YES

RM PRODUCT CODE :

RENTAL PRICE : 8,00 / Pcs

CATEGORY : BOOTH CONSTRUCTION & DECORATION

Floating Garden Grid (white/black) Expovision



PRODUCT SPECS :

200 x 100 cm
Black or White



Rigging points to be provided by the customer

DRY HIRE : NO

DRY HIRE PROF.USERS only : YES

RM PRODUCT CODE :

RENTAL PRICE : Price on demand

CATEGORY : BOOTH CONSTRUCTION & DECORATION

Refrigerator + Nespresso Kitcase Expovision

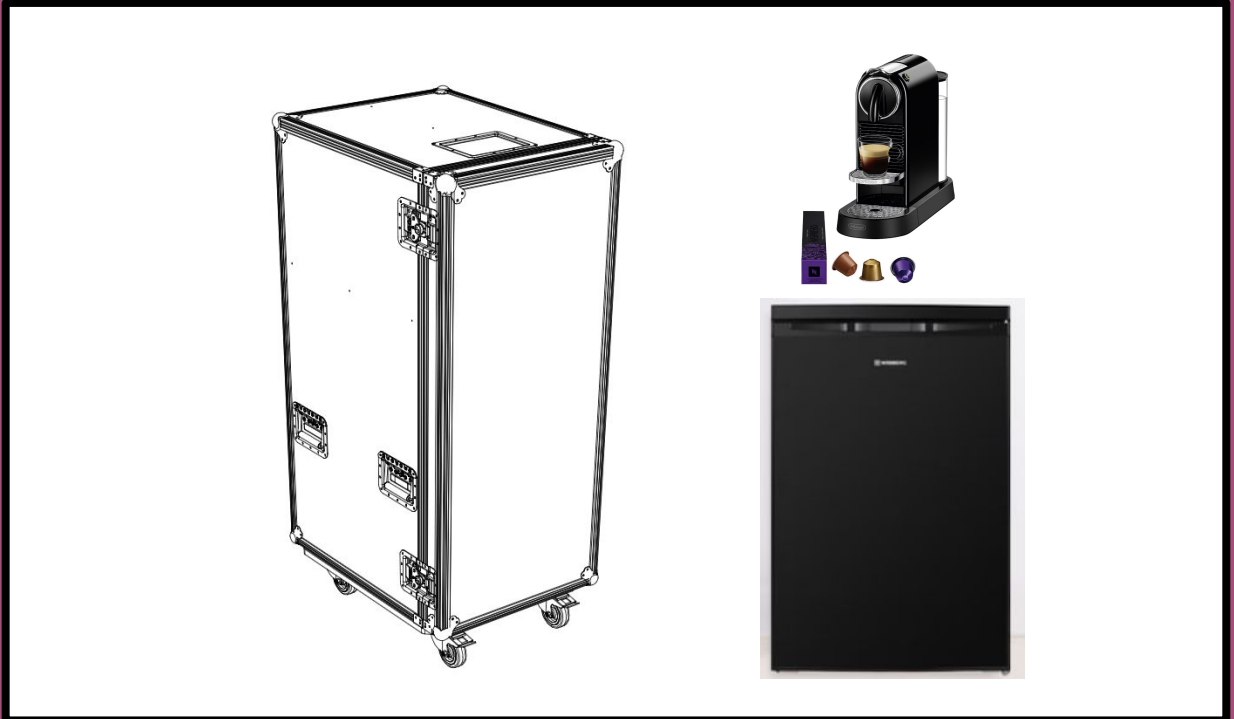

PRODUCT SPECS :

- Fridge 85cm High
- without freezer compartment = more space for drinks
- Nespresso Coffee machine with cups
- Drawers for cups , sugar , milk and spoons.
- In flight case 145 x 60 x 80 cm
- Coffee Cups on request.

DRY HIRE : YES

RM PRODUCT CODE :

RENTAL PRICE : 100,00

CATEGORY : Catering Equipment

While discounts apply to some of our products, this item is already priced at the best rate and is not eligible for further discounts.

EXPOVISION

EXPVISION

FURNITURE

*Our range is constantly
expanding, if there are
things you don't see,
please ask and we will
see how we can help you.*

KUBO SMART 70x70 Flexfurn



PRODUCT SPECS :

- KUBO 70X70
- Black or White
- 10 pieces / dolly



DRY HIRE : YES

RM PRODUCT CODE :

RENTAL PRICE : 20,00 / piece

CATEGORY : FURNITURE

Bar chair KASAR white Flexfurn



PRODUCT SPECS :

- Barstool Kasar White
- Up to 25 pieces //dolly



DRY HIRE : YES

RM PRODUCT CODE :

RENTAL PRICE : 10,00 / piece

CATEGORY : FURNITURE

Bar chair BLACK



PRODUCT SPECS :

- Barstool Black

DRY HIRE : YES

RM PRODUCT CODE :

RENTAL PRICE : 10,00 / piece

CATEGORY : FURNITURE

Bar chair Round Wood/Black



PRODUCT SPECS :

- Barstool Round Wood Black

DRY HIRE : YES

RM PRODUCT CODE :

RENTAL PRICE : 10,00 / piece

CATEGORY : FURNITURE

Chair JUNE Black / White Flexfurn



PRODUCT SPECS :

- June BLACK or White
- Up to 30 pieces / dolly

DRY HIRE : YES

RM PRODUCT CODE :

RENTAL PRICE : 5,00 / piece

CATEGORY : FURNITURE

Bistro Set 4 stoel + tafel Flexfurn



PRODUCT SPECS :

- Set = 4 chair + 1 table

DRY HIRE : YES

RM PRODUCT CODE :

RENTAL PRICE : 40,00 / set

CATEGORY : FURNITURE

Sunny Tafel Black 80 x80 Flexfurn



PRODUCT SPECS :

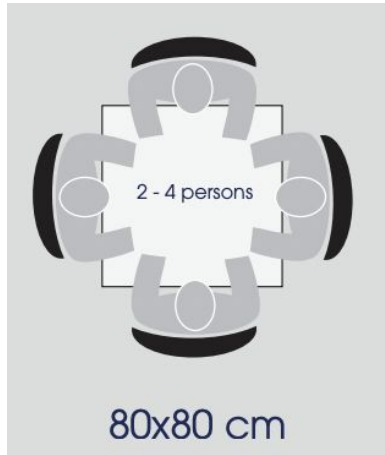

- a different table top sizes
- b 73 cm

DRY HIRE : YES

RM PRODUCT CODE :

RENTAL PRICE : 35,00

CATEGORY : FURNITURE